

**SERIES 800
HEAT RECOVERY SYSTEMS
CONSOLE MODELS**

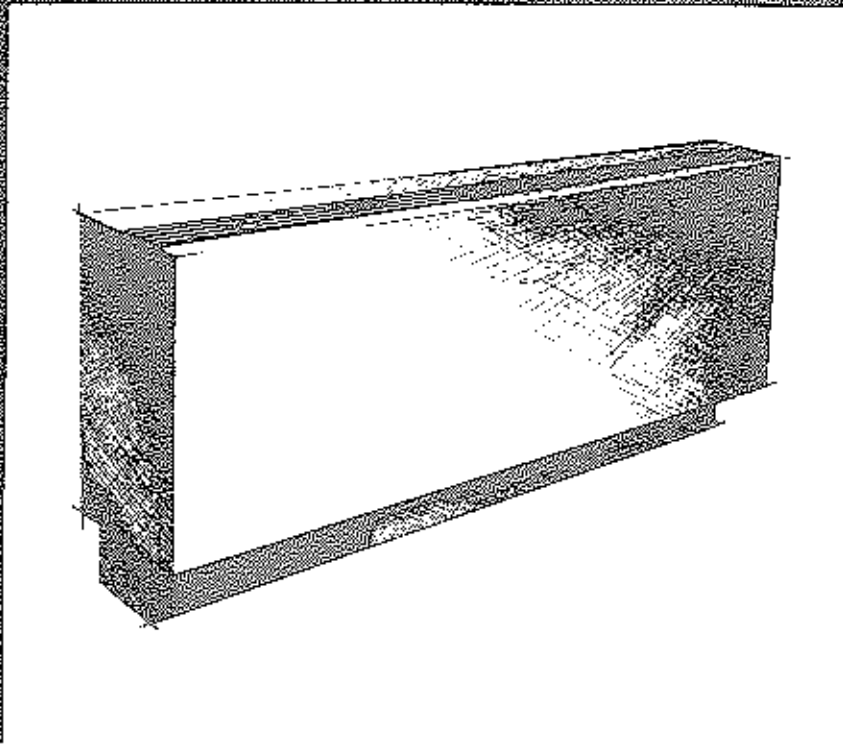

Friedrich® Climate
Master
Series

THE ENERGY ECONOMISERS

ENGINEERING DATA

The Climate Master Heat Recovery System

SELECTION PROCEDURE

The factors influencing the decision to use the Heat Recovery System will be quite varied, however, the basic criteria will be an air conditioning and heating load which will differ between areas of the building. These differences are influenced by lights, occupants, sun load, orientation, machinery, construction features and usage.

The first step in design proceeds in accordance with normal methods of heat gains, losses, ventilation, occupancy, lighting, etc. such as found in ASHRAE's Handbooks. Refer to Climate Master System Bulletin for fundamental data and variables on Heat Recovery System Design Principles.

Step by Step Selection of Two Pipe Console Unit:

1. Assume a load of 12,000 BTU cooling is required for the area in question to maintain an 80° DB 67° WB.
2. Assume a climatic condition of cooler (tower) design of 85° water off the tower.
3. Enter the 800-12 Cooling Operation curve at 85° entering water and read vertically to a GPM curve closely corresponding to the 12,000 BTU load on the left and read approximately 1.65 GPM to produce 12,000 BTU at 85° EW.
4. Continue the line vertically to the corresponding GPM curve at the top and from that intersection read horizontally to the right to intersect the Heat of Rejection curve and read BTU.
5. From this intersection read vertically downward to read 105° leaving water and 1.71 KW input.
6. Continue with this procedure for all of the console type Heat Recovery Units to obtain the total GPM required to do the job and the final leaving water temperature (taking into account diversity) for selection of the cooler. Follow normal procedures for pump selection taking into account pressure drops through the console units, cooler, heater, piping, valves and fittings. These pressure drops are obtainable from tables in the catalog.
7. Sensible Heat Ratios are given for corrections for other design conditions.
8. Follow the same procedure outlined above for selection of the heating capacity for the 800-12 already selected for cooling.
9. For winter operation assume a loop temperature of 75° entering water and enter the Heating Operation Curve at 1.65 GPM and read 14,800 BTU heating, 9,800 BTU heat of absorption, 63° leaving water, 1.55 KW input.
10. Using the heat of absorption factors for all units (taking into account diversity) the supplementary heater can be selected for either gas, oil or electric fuel.

Step by Step Selection of One Pipe Console Unit:

The basic components of a one pipe unit and two pipe unit are identical. A two pipe by definition means an individual supply and return to each unit balanced so each unit receives its given amount of GPM with all units receiving the same temperature of water at any given

time. A one pipe unit contains two monoflow tees which divert a given amount of water to each unit (usually 2.2 GPM). The units are in series in the loop and the loop must be supplied with 17.5 GPM regardless as to how many units are on the loop. Usually a maximum of eight units, depending on unit and monoflow sizing, is recommended for efficiency purposes.

1. For example, let's suppose we had 5 areas in a row to be treated between a supply and return riser. Select the units as per above except use the 2.2 GPM curve to obtain capacity data and decide on 5 800-12 units.
2. The GPM for the loop is automatically 17.5 GPM. Add up the loops to determine the total GPM for pump selection.
3. The pressure drop is obtained by adding the pressure drops for the 5 units for a total. Then proceed in normal manner.
4. Assume the same entering water in summer of 85° and winter of 75° using the heat of rejections and absorptions with diversity in selection of coolers and heaters.
5. At this point, however, the one pipe differs from the two pipe since 17.5 GPM of 85° water enters the first unit, 2.2 is deflected and heated then mixed with the bypassed 15.3 GPM before entering unit #2 at a slightly higher temperature than 85°. This continues throughout for all 5 units.
6. Example: We have 17.5 GPM at 85° entering first unit. From curves at 2.2 GPM 85° water we get a leaving water of 102.5° therefore, the water temperature entering the 2nd unit is calculated thus:
$$\begin{aligned} 2.2 \text{ GPM} \times 102.5^\circ &= 225.5 \\ 15.3 \text{ GPM} \times 85^\circ &= 1300.5 \\ \hline 1526.0 \div 17.5 &= 87.2^\circ \end{aligned}$$
7. With this new entering water temperature for the 2nd unit on the loop reenter the 800-12 curves at 2.2 GPM and read the revised capacities and so on for each individual unit on the loop to obtain the final leaving water temperature and resultant capacities of each unit.
8. The same procedure is followed for heating.

SYSTEM SAFETY CONTROLS

The temperature control of the system can be quite simple since each individual console, horizontal or vertical package unit is furnished with its own controls either for unit or remote mounting.

However, a system of water loop monitoring controls is desirable to perform the following functions:

1. A flow switch to indicate and alarm in case of no flow in system.
2. A high temperature water indicator and alarm in case the loop temperature should exceed a pre-set temperature.
3. A low temperature water indicator and alarm in case the loop temperature should fall below a pre-set temperature.

Controls for the cooler and heater are also necessary to operate these units to maintain the pre-set water loop conditions.

Additional controls such as time-clocks, low limits and timers may be specified as options.

Performance Data and Selection Curves

800-7

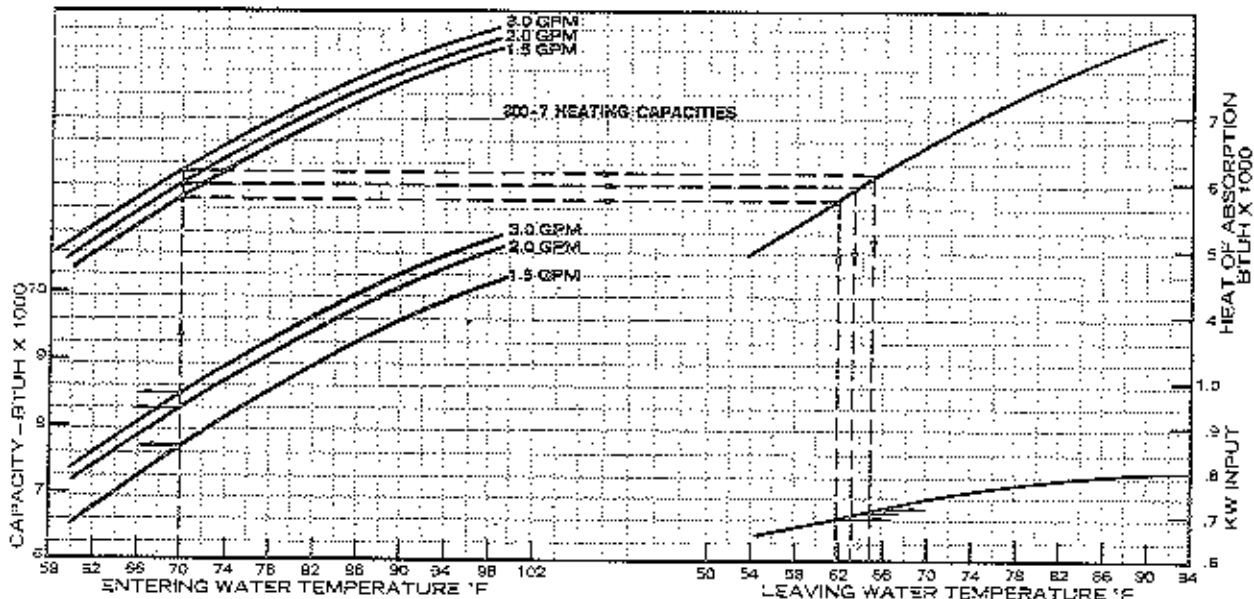
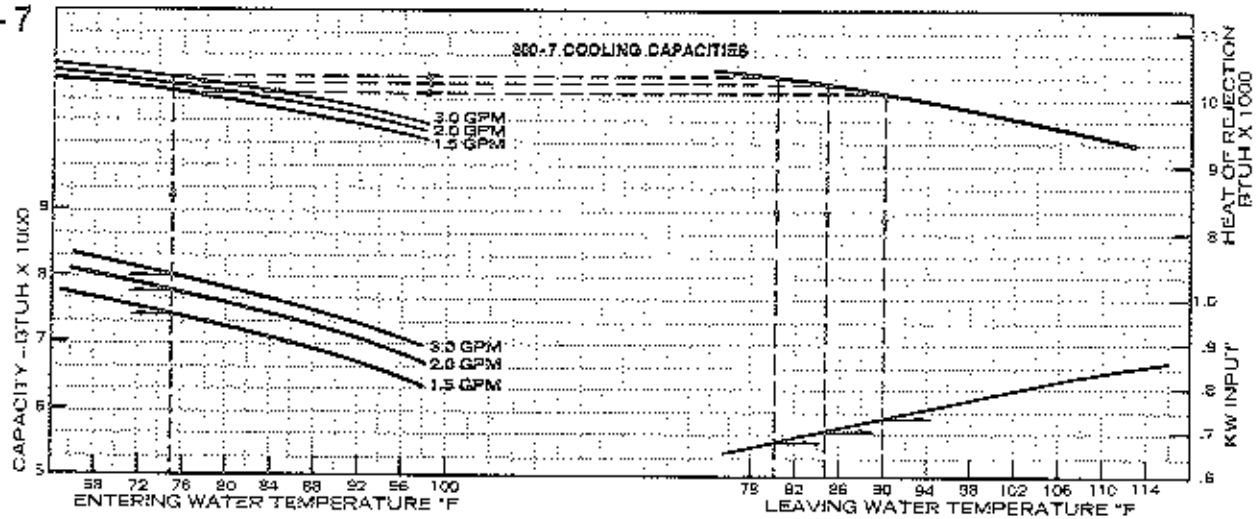

COOLING CAPACITY — Data Based on 95° L.W. 2 GPM

Ent. Air W.B.	Cooling Capacity BTUH	Sens. HT Ratio S/T				Heat of Rej. BTUH
		Ent. Air DB				
		75	80	85	90	
61	8,900	.83	.95	—	—	9,250
64	7,200	.72	.89	.95	.96	9,650
67	7,350	.61	.83	.90	.93	9,310
70	7,550	.51	.73	.81	.87	10,050
73	5,100	—	.56	.66	.71	10,600

ARI RATING — COOLING

¹ Net BTUH	7150
² Power Input — KW	.82
EER	9.7
Heat of Rej.	9750
Water Flow — GPM	1.85

ELECTRICAL DATA

Volts	Phase	HZ	Comp. FLA	Comp. LRA	Bl. FLA	Min. Wire Size	Max. Fuse Size
208/230	1	60	4.0	20.0	.5	#14	15A
265	1	60	3.9	22.3	.5	#14	15A

AIR DELIVERY

HS CFM/RPM	380/850
LS CFM/RPM	340/800

ARI RATING — HEATING

² Net BTUH	7100
² Power Input — KW	.75
C.O.P.	2.9
Heat of Absorb.	5000
Water Flow — GPM	1.85

WATER PRESSURE DROP

GPM	1.5	2.0	3.0
Ft. H ₂ O	.92	2.8	5.7

HEATING CORRECTION FACTORS

Ent. Air DB	60	70	80
Mult.	1.03	1.0	.97

¹Based on 85° DB/67° WB entering air, 85° EWT, 95° LWT.

²Includes allowance for cooling lower fan motor and water circulating pump motor inputs according to ARI Std. 240.

³Based on 70° DB entering air, 61° EWT.

Performance Data and Selection Curves

800-9

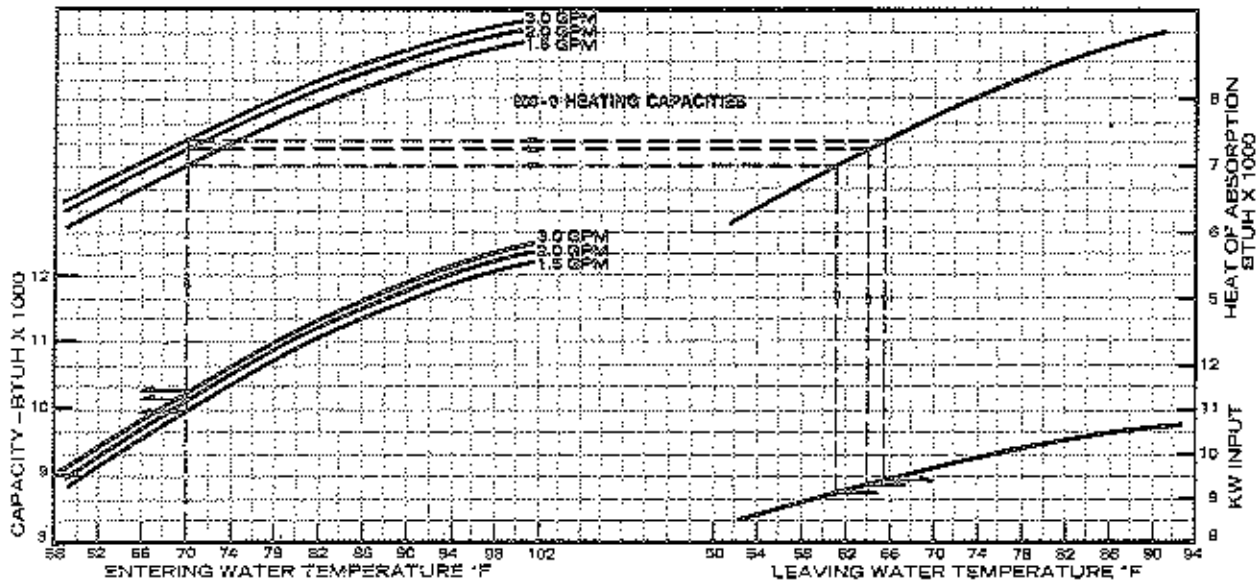
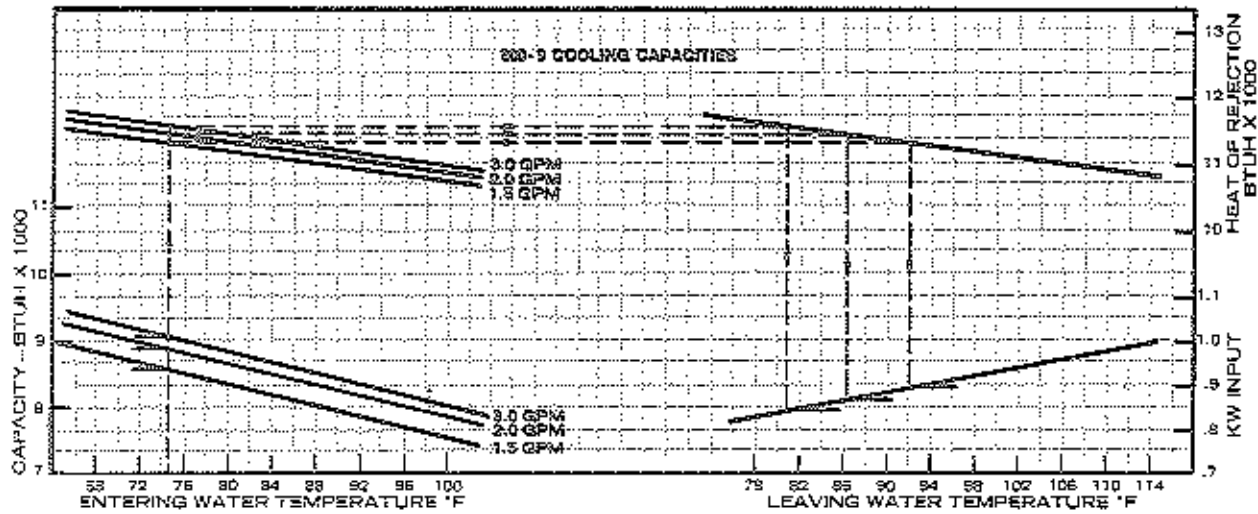

COOLING CAPACITY — Data Based on 95° L.W. 2 GPM

Ent. Air W.B.	Cooling Capacity BTUH	Sens. HT Ratio S/T				Heat of Rej. BTUH
		Ent. Air DB				
		75	80	85	90	
81	7,350	.80	.92	—	—	9,995
84	7,870	.69	.86	.92	.94	10,800
87	8,550	.59	.80	.87	.89	11,400
70	8,930	.49	.70	.78	.84	11,770
73	9,580	—	.54	.64	.64	12,570

ARI RATING — COOLING

¹ Net BTUH	8750
² Power Input — KW	1.01
EER	8.7
Heat of Rej.	11,575
Water Flow — GPM	2.3

ELECTRICAL DATA

Volts	Phase	NZ	Comp. FLA	Comp. LRA	BL. FLA	Min. Wire Size	Max. Fuse Size
208/230	1	50	4.4	21.3	.5	#12	15A
265	1	60	3.9	22.3	.5	#14	15A

AIR DELIVERY

HS CFM/RPM	380/850
LS CFM/RPM	340/800

ARI RATING — HEATING

¹ Net BTUH	9350
² Power Input — KW	.965
C.O.P.	2.8
Heat of Absorb.	6635
Water Flow — GPM	2.3

WATER PRESSURE DROP

GPM	1.5	2.0	3.0
Ft. H ₂ O	.92	2.8	6.7

HEATING CORRECTION FACTORS

Ent. Air DB	60	70	80
Mult.	1.03	1.0	.98

¹Based on: 80° D3/67° WB entering air, 85° EWT, 35° LWT.

²Includes allowance for cooling tower fan motor and water circulating pump motor inputs according to ARI Std. 240.

³Based on: 70° DB entering air, 60° EWT.

Performance Data and Selection Curves

800-12

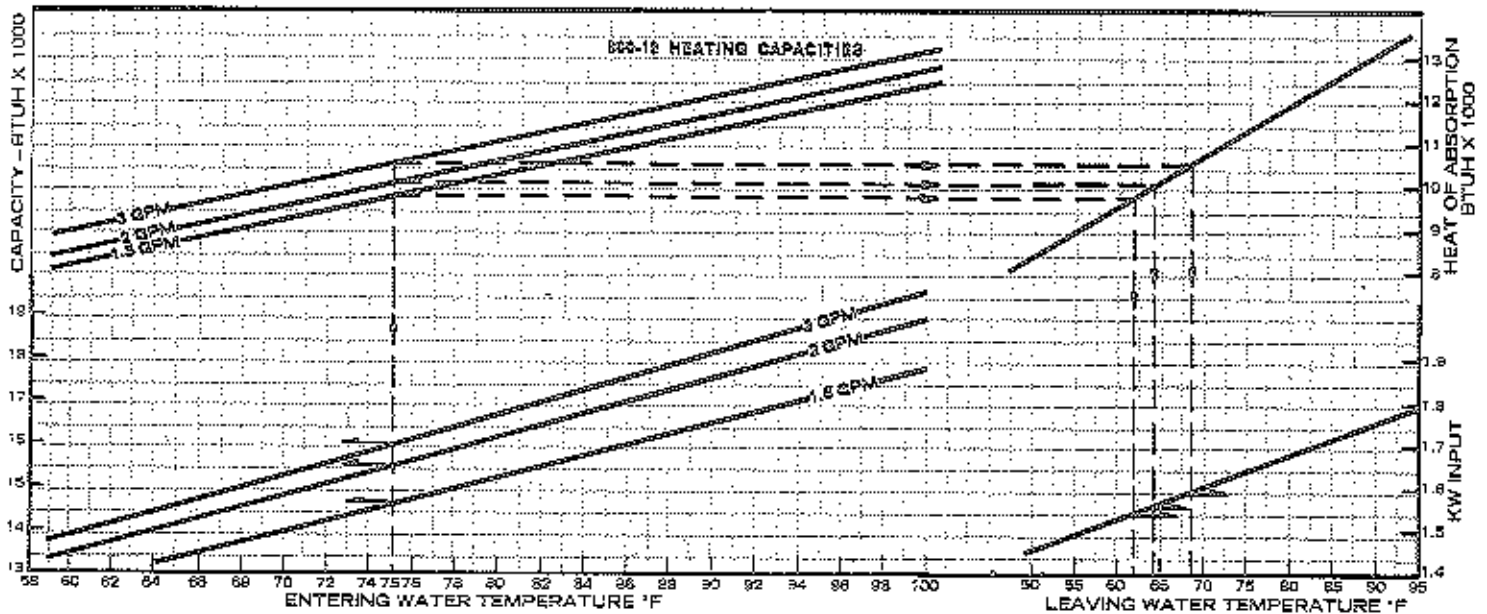
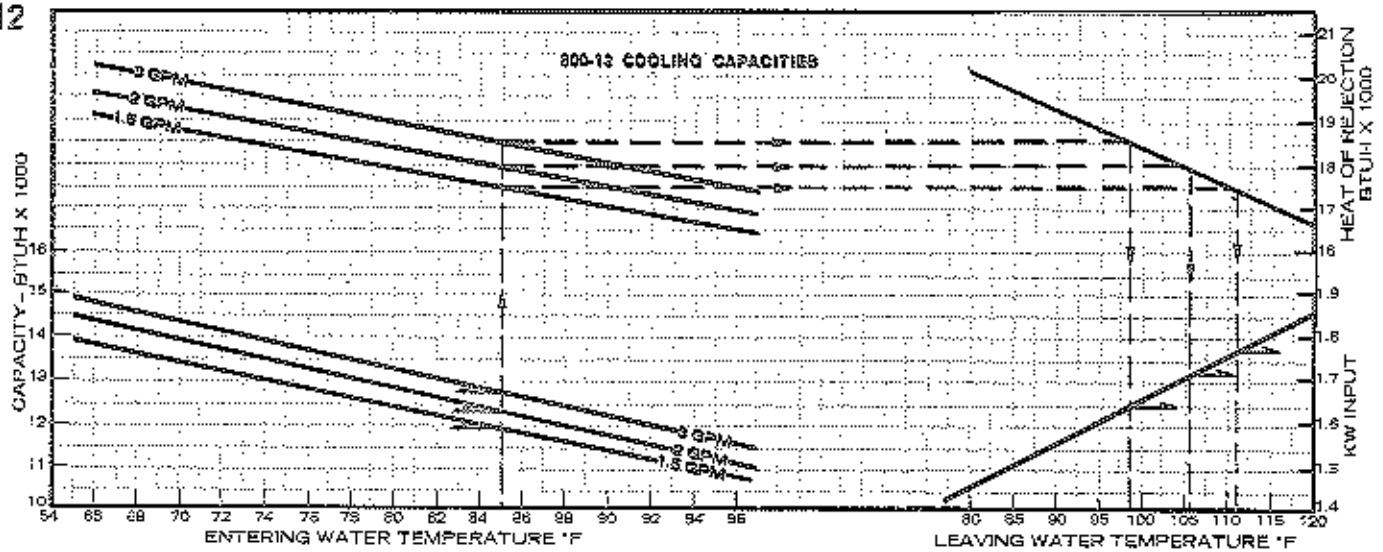

COOLING CAPACITY — Data Based on 95° L.W. 2 GPM

Ent. Air W.B.	Cooling Capacity BTUH	Sens. HT Ratio S/T				Heat of Rej. BTUH
		Ent. Air DB				
		75	80	85	90	
61	12,400	.77	.85	.89	---	17,700
64	12,900	.72	.79	.84	.91	18,200
67	13,400	.62	.68	.79	.85	18,700
70	14,000	.56	.60	.71	.77	19,200
73	14,500	.50	.53	.64	.76	19,800

ARI RATING — COOLING

¹ Net BTUH	13,400
² Power Input — KW	1.74
SER	7.7
Heat of Rej.	18,700
Water Flow — GPM	3.74

ELECTRICAL DATA

Volts	Phase	HZ	Comp. FLA	Comp. LRA	Sl. FLA	Min. Wire Size	Max. Fuse Size
208/230	1	60	5.8	37.5	.8	#14	15A
265	1	60	6.4	36.0	.8	#14	15A

AIR DELIVERY

HS CFM/RPM	425/1080
LS CFM/RPM	375/950

ARI RATING — HEATING

¹ Net BTUH	13,400
² Power Input — KW	1.6
C.O.P.	2.5
Heat of Absorb.	8500
Water Flow — GPM	3.74

WATER PRESSURE DROP

GPM	1.5	2.0	3.0
Ft. H ₂ O	4.73	6.3	10.1

HEATING CORRECTION FACTORS

Ent. Air DB	60	70	80
Mult.	1.03	1.00	.965

¹Based on: 80° DB/67° WB entering air, 85° EWT, 95° LWT.
²Includes allowance for cooling tower fan motor and water circulating pump motor inputs according to ARI Std. 240.
³Based on: 73° DB entering air, 60° EWT.

Performance Data and Selection Curves

800-16

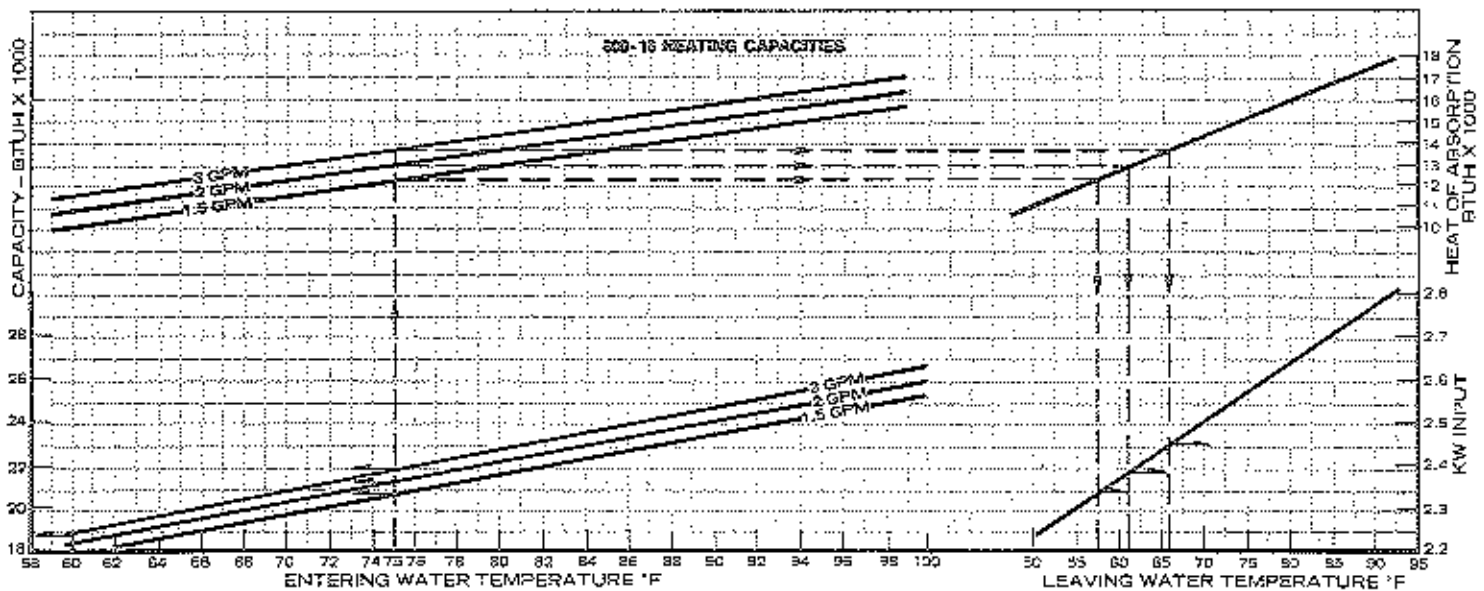
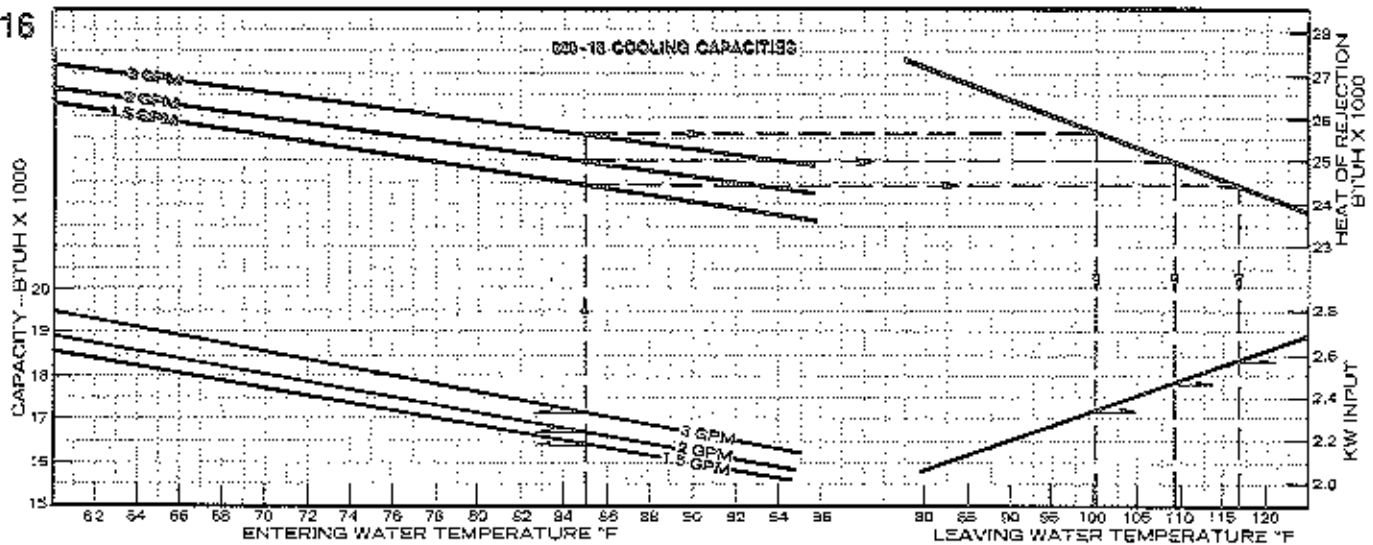

COOLING CAPACITY — Data Based on 95° L.W. 2 GPM

Ent. Air W.B.	Cooling Capacity BTUH	Sens. HT Ratio S/T				Heat of Rej. STUH
		Ent. Air DB				
		75	80	85	90	
61	16,800	.53	.79	.85	—	24,100
64	17,400	.51	.71	.82	.86	25,000
67	18,100	.53	.63	.71	.80	26,100
70	18,800	.48	.53	.62	.72	27,000
73	19,500	.40	.49	.53	.64	28,100

ARI RATING — COOLING

¹ Net BTUH	18,000
² Power Input — KW	2.45
EER	7.3
Heat of Rej.	25,800
Water Flow — GPM	5.1

ELECTRICAL DATA

Volts	Phase	HZ	Comp. FLA	Comp. LRA	Bl. FLA	Min. Wire Size	Max. Fuse Size
208/230	1	60	10.7	57.0	.8	#14	20A
265	1	50	9.1	55.0	.8	#14	20A

AIR DELIVERY

HS CFM/RPM	425/1080
LS CFM/RPM	375/950

ARI RATING — HEATING

¹ Net BTUH	18,800
² Power Input — KW	2.3
C.O.P.	2.4
Heat of Absorb.	11,250
Water Flow — GPM	5.1

WATER PRESSURE DROP

GPM	1.5	2.0	3.0
Fl. H ₂ O	2.32	4.06	6.4

HEATING CORRECTION FACTORS

Ent. Air DB	60	70	80
Mult.	1.03	1.00	.965

¹Based on: 85° DB/67° WB entering air, 85° EWT, 55° LWT.

²Includes allowance for cooling tower fan motor and water circulating pump motor inputs according to ARI Std. 240.

³Based on: 75° DB entering air, 63° EWT.

Dimensions

**TWO PIPE
RIGHT HAND
(Left Hand Reverse)**

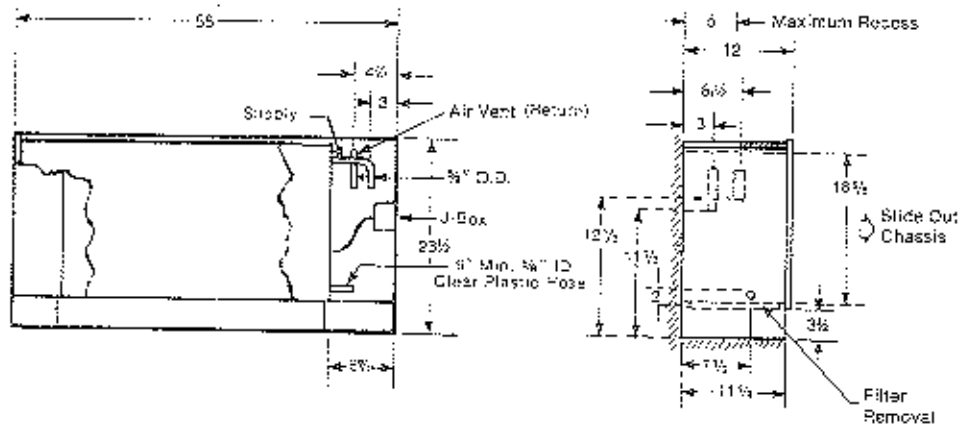

**ONE PIPE
RIGHT HAND
(Left Hand
Water Enters
From Left)
(Left Hand only for
Electric & Base)**

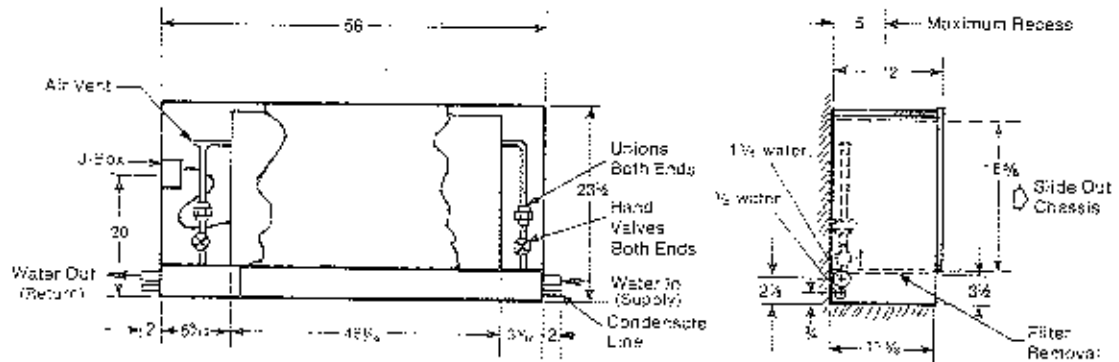

**TWO PIPE
RIGHT HAND
CHASSIS AND BASE
FOR CUSTOM ENCLOSURE & J BOX
BY OTHERS
(Left Hand Reverse)**

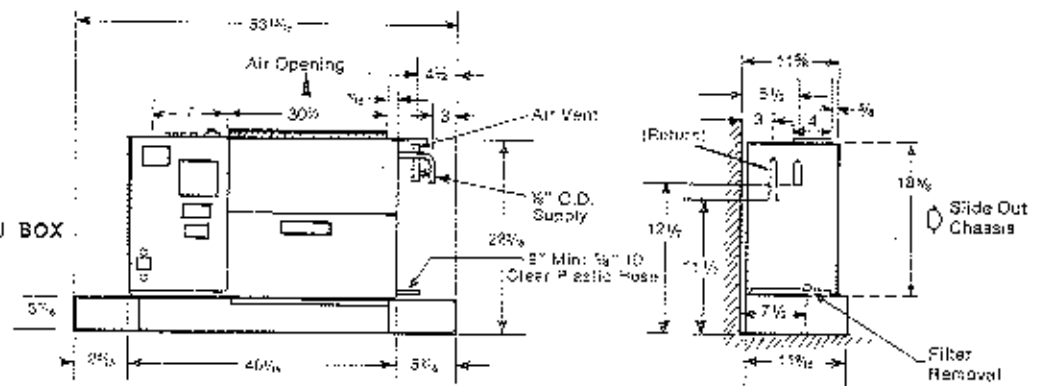

**ONE PIPE
RIGHT HAND
CHASSIS AND BASE
FOR CUSTOM ENCLOSURE
& J BOX BY OTHERS
(Left Hand only for
Electric & Base)**

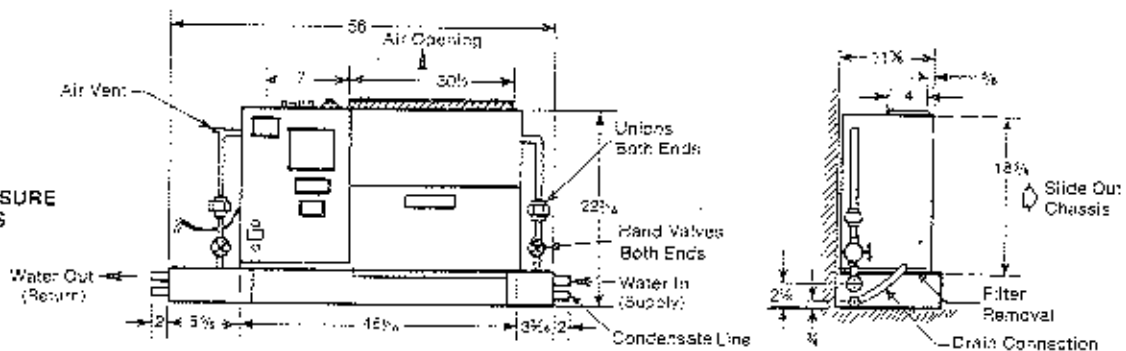

Note: Units with custom enclosures with front return can be used. The unit filter is mounted on the front. The chassis can thus be mounted on a one inch pad with piping either behind the unit or below the floor thus minimizing overall height to 19 3/4\"/>

SHIPPING WEIGHT (lbs.)	800-7	800-9	800-12	800-16
	187	194	220	230

Specifications

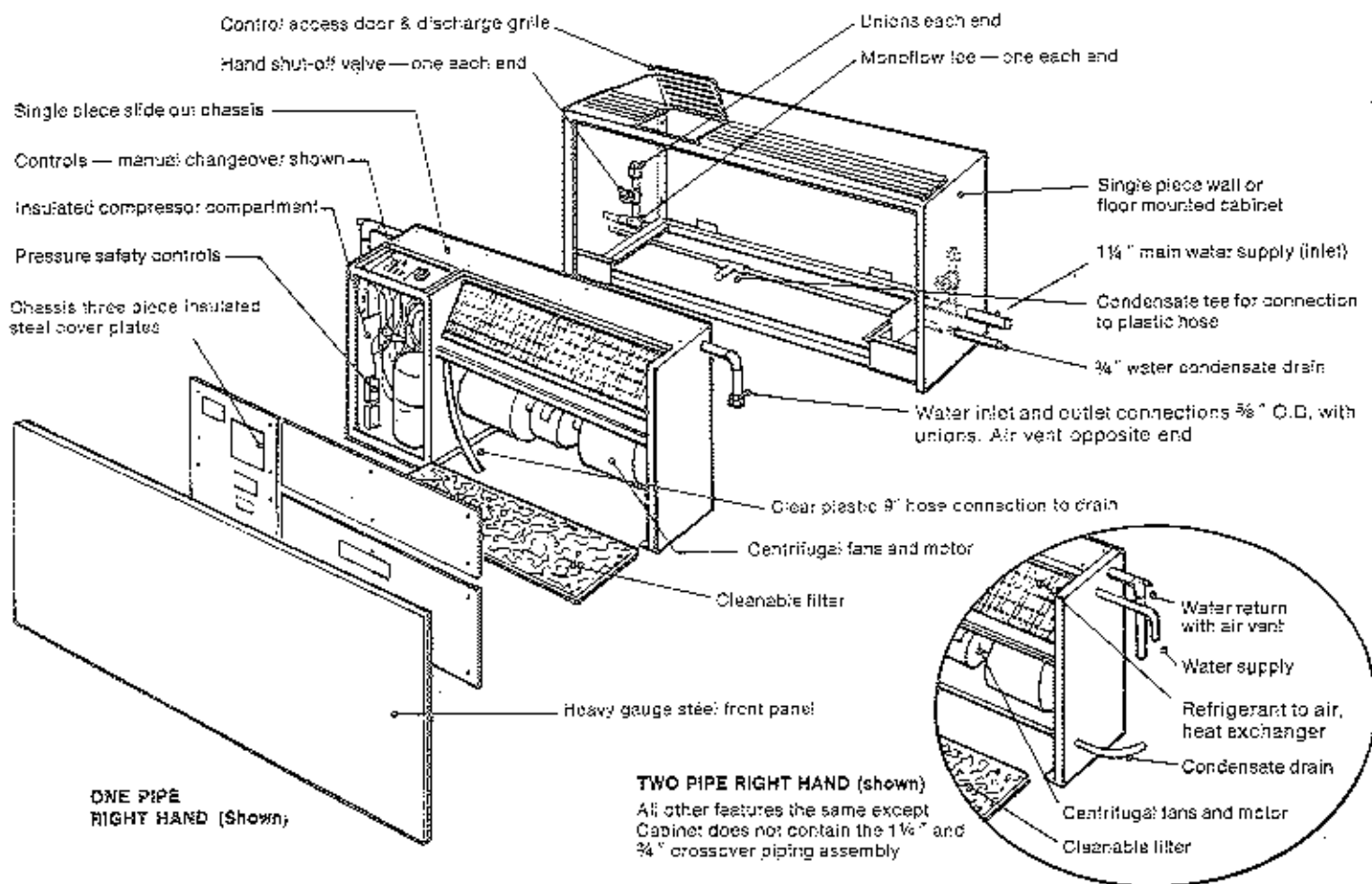

CABINET — Heavy gauge furniture steel finished in baked enamel with bottom air return and top discharge. Extruded aluminum 15" discharge grille with control access door. Cabinet is single piece designed to be either floor or wall mounted. Optional colors available.

CHASSIS — Single Piece slide out consisting of:

1. Compressor, self-contained, welded hermetically sealed with built-in overload protection, internally spring mounted and externally rubber isolated mounted in insulated compartment.
2. Refrigerant to water heat exchanger, concentric copper tubing in steel tubing with co-axial fin separators.
3. Refrigerant to air heat exchanger, aluminum fins copper tubes blow "through" design with insulated drain pan.
4. Refrigerant reversing valve electrically operated internally wired to control selection module.
5. Dual pressure limit controls, manual reset for high and low pressure refrigeration circuit protection.
6. Fan motor with thermal overload protection.
7. Fans forward curve, slow speed double width for easy removal of motor and fan wheels without removing chassis.
8. Insulation provided in compressor compartment, fan compartment and on the three removable access panels.
9. Filter cleanable aluminum wire mesh removable from bottom without removing front panel.

FRONT PANEL — Optional with vinyl woodgrain walnut finish or std. steel in same finish as cabinet.

CONTROL OPTIONS:

1. Manual with selector switch for Off-LoCool-HiCool and Heat, with manually adjustable thermostat liquid filled sensing bulb in return air stream.
2. Automatic changeover unit mounted with Off-On selector switch and adjustable thermostat which automatically shifts operation to heating or cooling to satisfy the thermostat setting.
3. Remote thermostat operation, low voltage for either manual or automatic changeover control.
4. Optional fresh air control with motorized damper.
5. Security Guard Control option with low limit thermostat and program for random sequence start-up and shut-down with unit mounted timer for override and after-hours operation.
6. Master-Slave Control with time delay.

PIPING OPTIONS:

1. Two-Pipe consists of either Right or Left Hand connections for water. Copper pipe with manual air vent on return line. Two hand shut-off valves.
2. One-Pipe factory installed with 1 1/4" water crossover pipe with two monoflow tees, two hand shut-off valves, and matching unions, 3/4" water crossover condensate drain with tee for connection to plastic drain. Piping extended beyond cabinet for connection to run-out piping. Female or male threaded connections can be provided on 1 1/4" and 3/4" lines each end as option.

METAL FINISH — Cabinet is degreased, prime coated and given baked on enamel finish. Chassis metal parts constructed of zinc coated steel with acrylic outdoor finish.

Friedrich Climate Master Series

THE ENERGY ECONOMISERS

Contract Products • Central Cooling & Heating • Room Air Conditioners • Commercial Refrigeration

Friedrich Air Conditioning & Refrigeration Co.
P. O. Box 1540 • 4200 North Pan Am Expressway
San Antonio, Texas 78295, U.S.A.
Telex: 76-7431 • Telephone: (512) 225-2000