

Unit Specifications

Vertical Two-Stage Systems



***Ultra Classic™ VT Series
Geothermal Heating
and Cooling System
Sizes 036-072***



ULTRA CLASSIC SERIES

Residential Geothermal Heat Pumps

Specifications Catalog

Revision 06/07/04

Table of Contents

<i>Geothermal System Types</i>	2
<i>Design Features</i>	3
<i>ARI Performance Certification</i>	6
<i>Unit Model Key</i>	7
<i>Reference Calculations & Legend</i>	7
<i>Performance Data</i>	8
<i>Dimensions</i>	18
<i>Electrical & Physical Data</i>	19
<i>Control Features & Operation</i>	20
<i>Blower Performance</i>	20
<i>Thermostat Features & Wiring</i>	21
<i>CXM Features</i>	22
<i>Electrical Wiring Diagram</i>	24
<i>Auxiliary Heater Data</i>	25
<i>Engineering Guide Specs</i>	26
<i>Accessories & Options</i>	27
<i>Warranty Information</i>	27

Geothermal Advantages

Geothermal systems transfer heat from a building to the earth in the cooling mode, or from the earth to the building in the heating mode. Water is used as the heat transfer medium, either in a closed loop piping system, or by directly pumping well water. By using this stable thermal source, geothermal heat pumps provide energy efficient comfort the year around.

Highest Efficiency

The extremely high levels of efficiency are possible because a geothermal heat pump only uses electricity to move heat, not produce it. An Ultra Classic Series unit typically supplies 4 kilowatts of heat for every kilowatt of electricity used. Three of these kilowatts of heat come directly from the earth itself, and are clean, free and renewable. Most systems also include a hot water generator, which diverts a portion of the supplied heat to the domestic water heater. This provides a substantial portion of a family's hot water needs at a very low cost. Overall, geothermal technology offers the highest cooling EER's and heating COP's available in the industry.

Maximum Comfort

Geothermal heat pumps also provide higher comfort than traditional space conditioning equipment. By using a relatively warm source of heat such as the earth, supply air temperatures are significantly higher in the heating mode than traditional air-source heat pumps. Geothermal heat pumps also cycle much less often than fossil furnaces, creating a more consistent indoor temperature.

Geothermal heat pumps provide this comfort and economy in a single factory-tested and sealed packaged unit, without the need for field evacuation or charging, a noisy outdoor fan, or a flue.

Environmentally Friendly

The environmental advantages of geothermal systems have caught the eye of governmental agencies such as the Environmental Protection Agency (EPA) and the Department of Energy (DOE). Because it is lowest in CO₂ emissions, geothermal technology provides a solution to global warming by primarily using the natural energy of the earth. In contrast, traditional space conditioning systems depend upon the exploitation and burning of fossil energy sources with the resultant greenhouse gas emissions. Also, a minimal amount of HCFC22 is used in the factory sealed unit to prevent field leakage.

Better Investment

Low life-cycle costs are provided by the low operating and maintenance costs of geothermal systems, even when the higher initial installation costs are considered. In new construction, monthly energy savings typically exceed the increased mortgage payments. Therefore, cash flow is positive from the start. In retrofit systems, a buyer who purchases with cash usually realizes a return on investment well above certificate of deposit rates. And, with equipment life exceeding 20 years, a ClimateMaster Ultra Classic Series unit is a lasting investment.

Electric utilities, recognizing the dual benefits of high efficiency and low electric peak demand, often provide incentives to purchase these systems.

Geothermal System Types

Before choosing a geothermal system, many application factors must be evaluated including:

- ground water availability and quality
- loop installation costs
- land area available
- subsoil conditions
- local codes
- owner preferences

ClimateMaster dealers have the expertise and computer software to determine the best type of system. Many regions have contractors specializing in the installation of the ground loop portion of the system.

Closed Loop Systems

Closed Loop Systems consist of an underground heat exchange network of sealed, high strength polyethylene plastic pipe and a Flow Controller pumping module. When cooling, the loop fluid temperature will rise, and rejected heat is dissipated into the cooler earth.

Conversely, while heating, the loop fluid temperatures fall, and heat is absorbed from the earth. ClimateMaster Flow Controller pumping modules utilize small wattage pumps to circulate the water/antifreeze fluid within the piping system. The plastic heat exchange loop is closed and thermally fusion-welded at all connections in the same manner as natural gas distribution lines. Closed loops do not require a ground water supply or drain, and they are not subject to mineral build up.

Closed Loops can be installed in vertical or horizontal configurations, or submerged in a pond or lake. When designed properly, all three alternatives operate with similar efficiency. ClimateMaster high density polyethylene plastic pipe is used for all closed loop installations. Pipe connections are heat fused to form joints that are stronger than the pipe itself. ClimateMaster loop piping has a life expectancy in excess of 50 years.

Horizontal Loops are often considered when adequate land space is available. The pipes are placed in trenches, excavated by a backhoe or chain trencher to a depth of 4-6 feet. Depending on design, from 1-6 pipes are installed in each trench. Multiple pipe and coiled "slinky" configurations are often used to conserve land requirements and reduce overall installed loop costs. Horizontal boring

technology can also be used to install u-bend loops 10-15 feet deep with minimal landscaping disruption. Trench lengths range from 100-400 feet per system ton. Trenches must be spaced from 6-10 feet apart. The overall land area required ranges from 750-1,500 square feet per system ton.

Vertical Loops are the ideal choice when available land area is limited. Drilling equipment is used to bore small-diameter vertical holes. Two pipes joined together with a u-bend fitting are inserted into the vertical bore. Bore hole depth ranges from 100-300 feet per system ton. Bores must be spaced from 10-15 feet apart and properly grouted. The land space required ranges from 100-200 square feet per system ton.

Pond (Lake) Loops are very economical to install when a body of surface water is available, because excavation costs are virtually eliminated. Coils or "slinky" mats of pipe are simply placed on the bottom of the pond (lake). In most cases, 1/4 to 1/2 acre of water surface, with a minimum depth of 8-10 feet, is needed for a typical residence.

Ground Water Systems

Open loop systems utilize ground water as a direct energy source when good quality water is available at a reasonable pumping depth. A well must have enough capacity to deliver a minimum of 1.5 gpm per system ton during peak operation. Ditches, field tiles, ponds and streams are the most common discharge systems. Reinjection or semi-closed recirculation wells can also be utilized in some regions. In ideal conditions, an open loop application can be the most economical type of system to install.

Hybrid Closed Loop/Ground Water System

This system is unique to the Ultra Classic Series with its two independent refrigerant circuits. A closed loop of approximately 60% of the typical length is installed as the source for the first stage refrigerant circuit with ground or city water as the source for the second stage refrigerant circuit. The unit will operate the majority of the time on the earth loop and only use the well or city water a small percentage of the time. Benefits include a reduction in required land area, less expensive earth loop, increased overall cooling and heating capacity and efficiency, and low water usage. The annual well/city water consumption is approximately 20% of a typical groundwater application.



Horizontal Closed Loop



Vertical Closed Loop



Ground Water

Ultra Classic Design Features

The Ultra Classic Series has abundant features and industry leading efficiency which makes it the “Ultra Classic” of geothermal heat pumps.

Application Flexibility

- Five Capacities 036, 042, 048, 060 and 072.
- Extended range operation (25-110°F EWT) and flow rates as low as 1.5 gpm per ton.
- Vertical packages with either true right or true left return air options.
- Internally trapped condensate.
- Variable speed ICM2 fan motor adapts to various duct systems.
- Internal electric heat unit (optional) designed for easy field installation.
- Dual refrigerant circuit design allows sizing flexibility.
- Independent water connections allow hybrid ground loop/groundwater installation greatly reducing installed ground loop length requirements and water consumption.
- Circuit breaker protected loop and hot water generator pumps.
- Field selectable freeze protection setting for well or loop.
- Standard pre-installed 1” filter rack/duct collar with electrostatic filter.

Operating Efficiencies

- Highest efficiencies in ARI/ISO/ASHRAE 13256-1 ratings for heating COP’s, cooling EER’s with low water flow rates.
- Operating temperature range and high efficiency allow shorter loops.
- Optional hot water generator with internal pump generates hot water at considerable savings.
- No stage change off-time as in 2-speed designs.
- Dual refrigerant circuits provide the industry’s highest efficiencies at full capacity and reduced cycling losses.
- Rugged and highly efficient next generation rotary & scroll compressors.
- Oversized coaxial tube water-to-refrigerant heat exchangers operate at low liquid pressure drop. Convoluted copper (and optional cupronickel) water tube functions efficiently at low-flow rates and provides freeze-damage resistance.
- Oversized rifled tube/lanced aluminum fin, E-Coated air to refrigerant heat exchangers provide high efficiency at low face velocity.
- Large low RPM blowers with variable speed fan motors provide quiet, efficient air movement with high static capability.

Service Advantages

- Removable panels-4 for compressor 3 for air handling compartment.
- Brass swivel-type water connections for quick connection and elimination of wrenches or sealants during installation.
- Bi-directional thermal expansion valves.
- CXM control features an LED status light with memory feature for easy diagnostics.
- Circuit breaker protected 75VA control transformer.
- ICM2 control board features thermostat signal diagnostic LED’s, airflow display LED (100 CFM per flash), and simplified CFM selection.
- Cycle start low pressure and freeze stat bypass to prevent nuisance lock outs.
- Insulated divider and separate air handling/compressor compartments permit service testing without air bypass.
- Fan motors have quick attach wiring harness for fast removal.

- E-Coated refrigerant-to-air coil helps protect the coil from corrosion and extends life expectancy.
- Internal dropout blower for easy servicing.
- High and low pressure service ports on each refrigerant circuit.
- Accurate refrigerant sensing freeze protection.
- Independent refrigerant circuits provide redundancy and are less complex than many 2-speed designs.

Factory Quality

- All units are built on our Integrated Process Control Assembly System (IPCS). The IPCS is a unique state of the art manufacturing system that is designed to assure quality of the highest standards of any manufacturer in the water-source industry. Our IPCS system:
 - Verifies that the correct components are being assembled.
 - Automatically performs special leak tests on all joints.
 - Conducts pressure tests.
 - Performs highly detailed run test unparalleled in the HVAC industry.
 - System automatically won’t allow a “failed” unit to be packaged for shipment.
 - Run-test creates computer database for future service analysis and diagnostics.
- All units are water run-tested in all modes to insure efficiency and reliability.
- Heavy gauge galvanized steel cabinets use powder coated paint for durable and long-lasting finish.
- All refrigerant brazing is done in a nitrogen atmosphere.
- All units are deep evacuated to less than 100 microns prior to refrigerant charging.
- All joints are both helium and halogen leak tested to insure annual leak rate of less than 1/4 ounce.
- Coaxial heat exchanger, refrigerant suction lines and all water lines are fully insulated to eliminate condensation problems in low temperature applications.
- Noise Reduction features include: isolation mounted compressors; insulated compressor compartment; interior cabinet insulation using 1/2” coated glass fiber and variable speed fan.
- Safety features include: high pressure and loss of charge to protect the compressor; condensate overflow protection; freeze protection sensors to safeguard the coaxial heat exchanger and air coil; hot water high-limit hot water generator pump shutdown; fault lockout enables emergency heat and prevents compressor operation until thermostat or circuit breaker has been reset.

Simplified Controls

- Hybrid electromechanical and solid state components.
- Fan and compressor delays for quiet operation.
- Fan speed control provides higher heating supply air temperatures and better dehumidification in cooling.
- ‘CFM’ LED displays airflow.
- Dehumidification mode for higher latent cooling.

Options & Accessories

- Optional hot water generator with internally mounted pump.
- Optional cupronickel coaxial heat exchangers.
- Electronic thermostat.
- 90% efficient cleanable electrostatic air filters.
- Closed loop Flow Controller.
- Electronic auto-changeover thermostats with 3-stage heat and 2-stage cool and indicator LED’s.
- Hose kits.
- 1” deluxe filter rack/duct collar.
- Water manifold kit for single supply applications.

Ultra Classic Series Vertical Heat Pump

Optional internally mounted electric heat
(Mounted between the blower "throat" and
top panel)

Insulated cabinet
for quiet operation

Powder coated heavy gauge
galvanized steel cabinet

E-Coated oversized rifled
tube/lanced fin air coil

Soft starting variable speed ICM2
fan motor for quiet, efficient operation

Drop-Out blower and
fan motor assembly

Standard filter rack/duct collar
with electrostatic filter,
for easy filter access

Each unit run
tested with water

Bidirectional expansion valves

High efficiency twin rotary or next
generation scroll compressors provide
capacity modulation for accurate
load matching

Optional factory installed
hot water generator

Internally trapped condensate

Dual refrigerant circuits provides capacity
modulation for accurate load matching

Simple CXM and ICM2
control module provides reliable operation
and easier troubleshooting

Thermostat diagnostic and CFM LED's
for easier servicing

Brass swivel water
Connections for each circuit



About ARI/ISO/ASHRAE 13256-1

The performance standard ARI/ASHRAE/ISO 13256-1 became effective January 1, 2000 and replaces ARI Standards 320, 325, and 330. This new standard has three major categories: Water Loop (comparable to ARI 320), Ground Water (ARI 325), and Ground Loop (ARI 330). Although these standards are similar there are some differences:

Cooling EER unit of measure

The cooling efficiency is measured in EER (US version measured in Btuh per Watt. Metric version measured in Watt per Watt.) similar to the traditional COP measurement.

Entering Water Conditions Changes

Entering water temperatures have changed to reflect the centigrade temperature scale. For instance the water loop heating test is performed with 68°F (20°C) water instead of 70°F.

Entering air Conditions Changes

Entering air temperatures have changed to reflect the centigrade temperature scale. For instance the cooling tests are performed with 80.6°F (27°C) dry bulb and 66.2°F (19°C) wet bulb entering air instead of the traditional 80°F DB and 67°F WB entering air temperatures. 80.6/66.2 data may be converted to 80/67 using the entering air correction table.

Pump Power Correction

Within each model, only one water flow rate is specified for all three groups and pumping Watts are calculated using the following formula. This additional power is added onto the existing power consumption.

- Pump power correction = (gpm x 0.0631) x (Press Drop x 2990) / 300

Where 'gpm' is waterflow in gpm and 'Press Drop' is the pressure drop through the unit heat exchanger at rated water flow in feet of head.

Fan Power Correction

Fan power is corrected to zero external static pressure using the following equation. The nominal airflow is rated at a specific external static pressure. This effectively reduces the power consumption of the unit and increases cooling capacity but decreases heating capacity. These Watts are significant enough in most cases to increase EER and COP's fairly dramatically over ARI 320, 325, and 330 ratings.

- Fan Power Correction = (cfm x 0.472) x (esp x 249) / 300

Where 'cfm' is airflow in cfm and esp is the external static pressure at rated airflow in inches of water gauge.

ISO Capacity and Efficiency Equations

The following equations illustrate cooling calculations:

- ISO Cooling Capacity = Cooling Capacity (Btuh) + (Fan Power Correction (Watts) x 3.412)
- ISO EER Efficiency (W/W) = ISO Cooling Capacity (Btuh) x 3.412 / [Power Input (Watts) - Fan Power Correction (Watts) + Pump Power Correction (Watt)]

The following equations illustrate heating calculations:

- ISO Heating Capacity = Heating Capacity (Btuh) - (Fan Power Correction (Watts) x 3.412)
- ISO COP Efficiency (W/W) = ISO Heating Capacity (Btuh) x 3.412 / [Power Input (Watts) - Fan Power Correction (Watts) + Pump Power Correction (Watt)]

Test Condition Comparison Table

	ARI 320	ISO WLHP	ARI 325	ISO GWHP	ARI 330	ISO GLHP
Cooling						
Entering Air -DB/WB °F	80/67	80.6/66.2	80/67	80.6/66.2	80/67	80.6/66.2
Entering Water -°F	85	86	50/70	59	77	77
Fluid Flow Rate	Note 1	Note 2	Note 2	Note 2	Note 2	Note 2
Heating						
Entering Air -°F	70	68	70	68	70	68
Entering Water -°F	70	68	50/70	50	32	32
Fluid Flow Rate	Note 1	Note 2	Note 2	Note 2	Note 2	Note 2

ARI/ISO/ASHRAE 13256-1 Performance

Model	Capacity Modulation	Liquid Flow (gpm)	Air Flow (cfm)	Water Loop Heat Pump				Ground Water Heat Pump				Ground Loop Heat Pump			
				Cooling 86°F		Heating 68°F		Cooling 59°F		Heating 50°F		Cooling 77°F		Heating 32°F	
				Capacity Btuh	EER Btuh/W	Capacity Btuh	COP	Capacity Btuh	EER Btuh/W	Capacity Btuh	COP	Capacity Btuh	EER Btuh/W	Capacity Btuh	COP
036	Full	8.0	1200	Not Rated				38,600	21.4	32,600	4.3	35,900	16.3	26,300	3.7
	Part	4.0	660					19,400	22.8	16,400	4.6	18,700	20.0	14,600	4.2
042	Full	10.0	1400					43,100	20.0	38,500	4.2	40,600	16.0	31,200	3.7
	Part	5.0	770					20,600	21.4	18,800	4.6	19,700	18.7	16,100	4.0
048	Full	12.0	1600					51,600	21.1	42,500	4.4	49,100	17.3	35,900	4.0
	Part	6.0	880					23,300	22.0	19,200	4.7	22,700	20.0	17,800	4.5
060	Full	14.0	2000					64,200	19.2	56,300	4.1	60,700	15.3	46,400	3.5
	Part	7.0	1100					32,400	21.2	24,200	4.1	31,000	18.5	24,800	4.2
072	Full	14.0	2130					70,900	17.0	64,557	4.1	67,400	13.7	51,800	3.4
	Part	7.0	1214					35,600	19.4	30,600	4.3	35,100	17.3	27,800	4.0

Cooling capacities based upon 80.6°F DB, 66.2°F WB entering air temperature.
 Heating capacities based upon 68°F DB, 59°F WB entering air temperature.
 All ratings based upon 230V operation.

Certified in accordance with the ARI/ISO Standard 13256-1 Certification Program, which replaces ARI Standard-320, 325, and 330.



Rev.: 5/10/01N

Model	Capacity Modulation	Liquid Flow (l/s)	Air Flow (l/s)	Water Loop Heat Pump				Ground Water Heat Pump				Ground Loop Heat Pump			
				Cooling 30°C		Heating 20°C		Cooling 15°C		Heating 10°C		Cooling 25°C		Heating 0°C	
				Capacity Watts	EER (W/W)	Capacity Watts	COP	Capacity Watts	EER (W/W)	Capacity Watts	COP	Capacity Watts	EER (W/W)	Capacity Watts	COP
036	Full	0.50	566	Not Rated				11,313	6.3	9,555	4.3	10,522	4.8	7,708	3.7
	Part	0.25	312					5,686	6.7	4,807	4.6	5,481	5.9	4,279	4.2
042	Full	0.63	661					12,632	5.9	11,284	4.2	11,899	4.7	9,144	3.7
	Part	0.38	363					6,038	6.3	5,510	4.6	5,774	5.5	4,719	4.0
048	Full	0.63	755					15,123	6.2	12,456	4.4	14,390	5.1	10,522	4.0
	Part	0.38	415					6,829	6.4	5,627	4.7	6,653	5.9	5,217	4.5
060	Full	0.82	944					18,816	5.6	16,501	4.1	17,790	4.5	13,599	3.5
	Part	0.44	519					9,496	6.2	7,093	4.1	9,086	5.4	7,268	4.2
072	Full	0.82	1038					20,780	5.0	18,921	4.1	19,754	4.0	15,182	3.4
	Part	0.44	571					10,434	5.7	8,968	4.3	10,287	5.1	8,148	4.0

Cooling capacities based upon 27°C DB, 19°C WB entering air temperature.
 Heating capacities based upon 20°C DB, 15°C WB entering air temperature.
 All ratings based upon 230V operation.

Certified in accordance with the ARI/ISO Standard 13256-1 Certification Program, which replaces ARI Standard-320, 325, and 330.



Rev.: 5/10/01N

Model Key

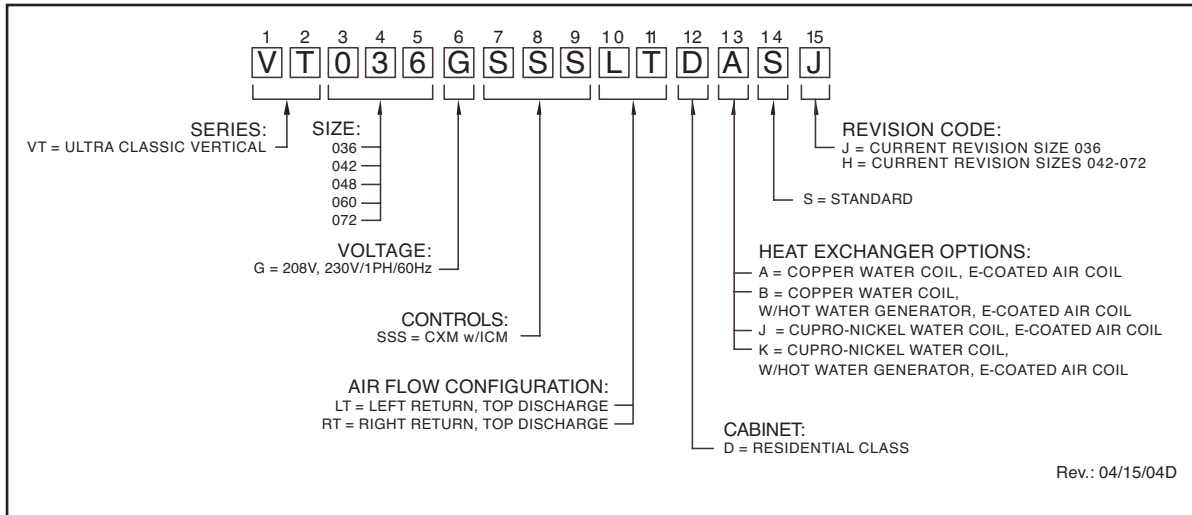

Reference Calculations & Legend

Heating		Cooling	
$LWT = EWT - \frac{HE}{GPM \times 500}$		$LWT = EWT + \frac{HR}{GPM \times 500}$	$LC = TC - SC$
$LAT = EAT + \frac{HC}{CFM \times 1.08}$		$LAT (DB) = EAT (DB) - \frac{SC}{CFM \times 1.08}$	$S/T = \frac{SC}{TC}$

CFM = airflow, cubic feet/minute	HWC = hot water generator (desuperheater capacity, BTUH)
EWT = entering water temperature	EER = Energy Efficiency Ratio = BTU output/Watt input
GPM = water flow in gallons/minute	COP = Coefficient of Performance = BTU output/BTU input
EAT = entering air temperature, Fahrenheit (dry bulb/wet bulb)	LWT = leaving water temperature, °F
HC = air heating capacity, BTUH	LAT = leaving air temperature, °F
TC = total cooling capacity, BTUH	LC = latent cooling capacity, BTUH
SC = sensible cooling capacity, BTUH	S/T = sensible to total cooling ratio
KW = total power unit input, kilowatts	WPD = water pressure drop (psi & ft. hd.)
HR = total heat of rejection, BTUH	
HE = total heat of extraction, BTUH	

Air Flow Correction Factors

AirFlow Pin Setting	Cooling Corrections				Heating Corrections		
	Total Cap	Sens Cap	Power	Heat of Rej	Htg Cap	Heat of Ext	Power
1	0.980	0.958	0.974	0.946	0.981	0.983	0.983
2	0.991	0.980	0.988	0.971	0.989	0.990	0.987
3	1.000	1.000	1.000	1.000	1.000	1.000	1.000
4	1.006	1.015	1.010	1.028	1.007	1.004	1.012

Rev.: 04/02/01B

Entering Air Correction Factors

Heating Corrections				Cooling Corrections										
Ent Air DB °F	Htg Cap	Power	Heat of Ext	Ent Air WB °F	Total Clg Cap	Sens Clg Cap Multiplier - Entering DB °F						Power	Heat of Rej	
						70	75	80	80.6	85	90			95
60	1.015	0.920	1.048	60	0.981	0.883	1.100	1.262	1.271	1.337	1.409	1.482	0.998	0.984
65	1.008	0.958	1.026	65	0.994	0.659	0.873	1.092	1.117	1.296	1.410	1.483	0.999	0.996
68	1.003	0.983	1.010	68.2	0.998	0.607	0.819	1.037	1.062	1.244	1.383	1.480	1.000	0.998
70	1.000	1.000	1.000	67	1.000	0.572	0.783	1.000	1.025	1.210	1.366	1.478	1.000	1.000
75	0.993	1.043	0.977	70	1.055	0.442	0.647	0.861	0.888	1.082	1.300	1.470	1.008	1.048
80	0.987	1.090	0.952	75	1.127		0.430	0.633	0.659	0.848	1.070	1.292	1.017	1.109

Italics denotes sensible capacity equals total capacity.

Rev.: 04/02/01B

ARI/ISO/ASHRAE 13256-1 uses entering air conditions of Clg- 80.6°F DB/66.2°F WB and Htg- 68°F DB/59°F WB.

Discontinued Standards ARI 320, 325, and 330 used entering air conditions of Clg- 80°F DB/67°F WB and Htg- 70°F DB (bold print).

Performance Data — Ultra Classic Model 036 - Part Load

Model 036 Part Load
Rated Air Flow 660 CFM

EWT °F	GPM	WPD†		COOLING - EAT 80/67 °F						HEATING - EAT 70°F																	
		PSI	FT	TC	SC	kW	HR	EER	HWC	HC	kW	HE	LAT	COP	HWC												
20	2.0	1.2	2.8	Operation Not Recommended																							
	3.0	2.2	5.0																								
	4.0	3.5	8.0																								
30	2.0	1.2	2.7							Operation Not Recommended						1.0	1.01	7.5	85.4	3.18	2.2						
	3.0	2.1	4.8													1.9	1.04	8.4	86.7	3.58	2.3						
	4.0	3.4	7.8													12.5	1.06	8.9	87.6	3.67	2.5						
40	2.0	1.1	2.6													20.5	15.5	0.83	23.0	24.5	2.4	13.8	1.10	10.7	89.3	4.18	2.7
	3.0	2.0	4.7													21.0	15.6	0.76	23.3	27.5	2.3	14.5	1.12	10.9	90.4	4.18	2.9
	4.0	3.2	7.5													21.2	15.7	0.72	23.4	29.3	2.2	14.9	1.13	11.3	90.9	4.19	3.1
50	2.0	1.1	2.5													19.8	15.2	0.94	22.7	21.2	2.8	15.7	1.14	12.5	92.0	4.55	3.1
	3.0	1.9	4.5	20.3	15.4	0.86	22.9	23.6	2.6							16.5	1.16	12.7	93.2	4.54	3.3						
	4.0	3.1	7.2	20.6	15.5	0.82	23.1	25.0	2.5							17.0	1.18	13.0	93.9	4.55	3.5						
60	2.0	1.1	2.4	19.2	14.9	1.04	22.3	18.3	3.1							17.6	1.19	14.3	94.7	4.92	3.5						
	3.0	1.9	4.4	19.6	15.1	0.97	22.6	20.3	2.9	18.6	1.22	14.6	96.2	4.92	3.7												
	4.0	3.0	7.0	19.9	15.2	0.93	22.7	21.4	2.8	19.2	1.23	14.9	97.0	4.92	3.9												
70	2.0	1.0	2.3	18.5	14.6	1.15	22.0	16.0	3.4	19.7	1.24	16.2	97.6	5.29	3.9												
	3.0	1.8	4.2	19.0	14.8	1.08	22.2	17.6	3.1	20.8	1.26	16.4	99.2	5.25	4.1												
	4.0	2.9	6.7	19.2	14.9	1.04	22.3	18.4	3.1	21.5	1.28	16.8	100.2	5.30	4.3												
80	2.0	1.0	2.3	17.8	14.4	1.27	21.6	14.0	3.7	21.8	1.29	18.0	100.6	5.61	4.2												
	3.0	1.8	4.1	18.2	14.5	1.19	21.9	15.3	3.5	23.1	1.32	18.3	102.5	5.59	4.4												
	4.0	2.8	6.6	18.5	14.6	1.15	22.0	16.0	3.4	24.0	1.34	18.6	103.6	5.63	4.7												
90	2.0	0.9	2.2	17.1	14.0	1.38	21.3	12.4	4.0	24.0	1.34	19.4	103.7	5.25	4.2												
	3.0	1.7	3.9	17.5	14.2	1.31	21.5	13.4	3.8	25.6	1.38	20.9	105.9	5.43	4.4												
	4.0	2.7	6.3	17.7	14.4	1.27	21.6	13.9	3.7	26.4	1.39	21.7	107.1	5.57	4.7												
100	2.0	0.9	2.1	16.3	13.8	1.50	20.9	10.8	4.3	Operation Not Recommended																	
	3.0	1.7	3.8	16.8	13.9	1.43	21.1	11.7	4.1																		
	4.0	2.7	6.2	17.0	14.0	1.39	21.2	12.2	4.0																		
110	2.0	0.9	2.1	15.5	13.5	1.62	20.5	9.5	4.6																		
	3.0	1.6	3.7	15.9	13.6	1.55	20.7	10.2	4.4																		
	4.0	2.6	6.0	16.2	13.7	1.52	20.8	10.6	4.3																		

All Capacities in MBtuh.

Rev.: 04/02/011

Interpolation is permissible, extrapolation is not.

All entering air conditions are 80°F DB and 67°F WB in cooling and 70°F DB in heating.

All performance data is based upon the lower voltage of dual voltage rated units.

Operation below 40°F EWT is based upon 15% antifreeze solution.

See Performance Correction Tables for operating conditions other than those listed above.

† Water pressure drop representing single circuit.

Performance Data — Ultra Classic Model 036 - Full Load

Model 036 Full Load
Rated Air Flow 1200 CFM

EWT °F	GPM	WPD†		COOLING - EAT 80/67 °F						HEATING - EAT 70°F																	
		PSI	FT	TC	SC	kW	HR	EER	HWC	HC	kW	HE	LAT	COP	HWC												
20	4.0	1.2	2.8	Operation Not Recommended																							
	6.0	2.2	5.0																								
	8.0	3.5	8.0																								
30	4.0	1.2	2.7							Operation Not Recommended						22.4	2.20	14.9	87.3	2.99	2.2						
	6.0	2.1	4.8													24.4	2.27	16.9	88.8	3.55	2.3						
	8.0	3.4	7.8													25.6	2.31	17.9	89.7	3.64	2.5						
40	4.0	1.1	2.6													39.9	29.0	1.82	45.5	21.9	2.4	28.1	2.38	21.5	91.7	4.14	2.7
	6.0	2.0	4.7													40.9	29.4	1.68	46.0	24.3	2.3	29.5	2.42	22.1	92.8	4.13	2.9
	8.0	3.2	7.5													41.4	29.6	1.61	46.2	25.8	2.2	30.3	2.44	22.8	93.4	4.15	3.1
50	4.0	1.1	2.5	38.7	28.5	2.03	44.9	19.1	2.8							31.8	2.48	25.2	94.5	4.50	3.1						
	6.0	1.9	4.5	39.6	28.8	1.88	45.4	21.1	2.6							33.5	2.53	25.7	95.9	4.50	3.3						
	8.0	3.1	7.2	40.1	29.0	1.80	45.6	22.2	2.5							34.5	2.55	26.3	96.6	4.50	3.5						
60	4.0	1.1	2.4	37.3	27.9	2.24	44.2	16.7	3.1	35.7	2.58	28.9	97.6	4.87	3.5												
	6.0	1.9	4.4	38.3	28.3	2.09	44.7	18.3	2.9	37.7	2.64	29.5	99.1	4.88	3.7												
	8.0	3.0	7.0	38.8	28.5	2.02	44.9	19.2	2.8	38.9	2.67	30.1	100.0	4.87	3.9												
70	4.0	1.0	2.3	36.0	27.4	2.46	43.5	14.6	3.4	39.8	2.69	32.7	100.7	5.24	3.9												
	6.0	1.8	4.2	36.9	27.8	2.31	44.0	16.0	3.1	42.1	2.75	33.1	102.5	5.20	4.1												
	8.0	2.9	6.7	37.4	28.0	2.24	44.2	16.7	3.1	43.4	2.78	33.9	103.5	5.25	4.3												
80	4.0	1.0	2.3	34.6	26.7	2.68	42.8	12.9	3.7	44.0	2.80	36.5	103.9	5.55	4.2												
	6.0	1.8	4.1	35.5	27.1	2.53	43.3	14.0	3.5	46.6	2.86	36.9	106.0	5.53	4.4												
	8.0	2.8	6.6	35.9	27.4	2.46	43.5	14.6	3.4	48.2	2.90	37.7	107.2	5.57	4.7												
90	4.0	0.9	2.2	33.1	26.2	2.91	42.0	11.4	4.0	48.4	2.91	38.4	107.3	4.87	4.2												
	6.0	1.7	3.9	34.0	26.5	2.76	42.6	12.3	3.8	51.5	2.99	41.2	109.7	5.04	4.4												
	8.0	2.7	6.3	34.5	26.7	2.69	42.8	12.8	3.7	53.2	3.04	42.8	111.0	5.12	4.7												
100	4.0	0.9	2.1	31.7	25.6	3.15	41.4	10.1	4.3	Operation Not Recommended																	
	6.0	1.7	3.8	32.6	26.0	3.01	41.8	10.8	4.1																		
	8.0	2.7	6.2	32.9	26.1	2.94	42.0	11.2	4.0																		
110	4.0	0.9	2.1	30.1	25.0	3.39	40.6	8.9	4.6							Operation Not Recommended											
	6.0	1.6	3.7	31.0	25.4	3.25	41.0	9.5	4.4																		
	8.0	2.6	6.0	31.4	25.5	3.19	41.3	9.9	4.3																		

All Capacities in MBtuh.

Rev.: 04/02/01B

Interpolation is permissible, extrapolation is not.

All entering air conditions are 80°F DB and 67°F WB in cooling and 70°F DB in heating.

All performance data is based upon the lower voltage of dual voltage rated units.

Operation below 40°F EWT is based upon 15% antifreeze solution.

See Performance Correction Tables for operating conditions other than those listed above.

† Water pressure drop representing both circuits.

Performance Data — Ultra Classic Model 042 - Part Load

Model 042 Part Load
Rated Air Flow 770 CFM

EWT °F	GPM	WPD†		COOLING - EAT 80/67 °F						HEATING - EAT 70°F											
		PSI	FT	TC	SC	kW	HR	EER	HWC	HC	kW	HE	LAT	COP	HWC						
20	3.0	0.6	1.4	Operation Not Recommended																	
	4.0	1.0	2.2																		
	5.0	1.3	3.0																		
30	3.0	0.6	1.3													13.1	1.24	9.2	85.8	3.10	2.8
	4.0	0.9	2.1													14.7	1.27	10.6	87.7	3.38	3.0
	5.0	1.3	2.9													15.1	1.28	10.9	88.1	3.44	3.1
40	3.0	0.6	1.3													16.9	1.32	12.6	90.3	3.74	3.3
	4.0	0.9	2.1													17.3	1.33	13.0	90.8	3.80	3.5
	5.0	1.2	2.8													17.6	1.34	13.3	91.2	3.85	3.6
50	3.0	0.5	1.2													19.2	1.38	14.7	93.0	4.08	3.5
	4.0	0.9	2.0	19.7	1.39	15.2	93.7	4.16	3.7												
	5.0	1.2	2.7	20.1	1.39	15.6	94.1	4.21	3.8												
60	3.0	0.5	1.2	21.6	1.43	17.0	95.9	4.42	3.8												
	4.0	0.8	1.9	22.2	1.44	17.6	96.7	4.51	4.0												
	5.0	1.2	2.7	22.6	1.45	17.9	97.2	4.56	4.1												
70	3.0	0.5	1.2	24.0	1.48	19.2	98.9	4.73	4.1												
	4.0	0.8	1.8	24.8	1.50	19.9	99.8	4.82	4.4												
	5.0	1.1	2.5	25.2	1.51	20.4	100.3	4.88	4.5												
80	3.0	0.5	1.1	26.6	1.55	21.6	101.9	5.03	4.5												
	4.0	0.8	1.8	27.4	1.57	22.4	103.0	5.12	4.8												
	5.0	1.1	2.5	28.0	1.58	23.0	103.7	5.18	4.9												
90	3.0	0.5	1.1	29.2	1.62	24.1	105.2	5.30	4.8												
	4.0	0.8	1.7	30.3	1.64	25.0	106.4	5.40	4.9												
	5.0	1.0	2.4	30.9	1.66	25.6	107.2	5.45	5.0												
100	3.0	0.5	1.1	18.3	1.53	1.63	23.2	11.2	4.7	Operation Not Recommended											
	4.0	0.7	1.7	18.5	1.54	1.59	23.4	11.6	4.3												
	5.0	1.0	2.3	18.7	1.55	1.57	23.4	11.9	4.2												
110	3.0	0.5	1.0	17.4	1.50	1.78	22.8	9.8	5.3												
	4.0	0.7	1.7	17.7	1.52	1.74	22.9	10.2	4.9												
	5.0	1.0	2.3	17.8	1.52	1.71	23.0	10.4	4.8												

All Capacities in MBtuh.

Rev.: 04/02/01B

Interpolation is permissible, extrapolation is not.

All entering air conditions are 80°F DB and 67°F WB in cooling and 70°F DB in heating.

All performance data is based upon the lower voltage of dual voltage rated units.

Operation below 40°F EWT is based upon 15% antifreeze solution.

See Performance Correction Tables for operating conditions other than those listed above.

† Water pressure drop representing single circuit.

Performance Data — Ultra Classic Model 042 - Full Load

Model 042 Full Load
Rated Air Flow 1400 CFM

EWT °F	GPM	WPD†		COOLING - EAT 80/67 °F						HEATING - EAT 70°F																	
		PSI	FT	TC	SC	kW	HR	EER	HWC	HC	kW	HE	LAT	COP	HWC												
20	6.0	0.6	1.4	Operation Not Recommended																							
	8.0	1.0	2.2																								
	10.0	1.3	3.0																								
30	6.0	0.6	1.3							Operation Not Recommended						27.2	2.68	18.6	88.0	2.98	2.8						
	8.0	0.9	2.1													30.5	2.76	21.6	90.2	3.25	3.0						
	10.0	1.3	2.9													31.3	2.78	22.4	90.7	3.31	3.1						
40	6.0	0.6	1.3													46.3	33.1	2.12	52.9	21.9	2.4	35.1	2.87	25.8	93.2	3.59	3.3
	8.0	0.9	2.1													46.8	33.3	2.06	53.2	22.9	2.3	36.0	2.89	26.7	93.8	3.66	3.5
	10.0	1.2	2.8													47.1	33.4	2.02	53.4	23.6	2.3	36.6	2.90	27.3	94.2	3.70	3.6
50	6.0	0.5	1.2	44.9	32.5	2.31	52.0	19.5	2.6							39.9	2.97	30.3	96.4	3.92	3.5						
	8.0	0.9	2.0	45.4	32.7	2.25	52.3	20.3	2.5							41.0	3.01	31.3	97.1	4.00	3.7						
	10.0	1.2	2.7	45.7	32.8	2.20	52.5	20.8	2.4							41.7	3.03	32.0	97.6	4.04	3.8						
60	6.0	0.5	1.2	43.4	31.8	2.51	51.1	17.3	2.9	44.8	3.10	34.9	99.6	4.24	3.8												
	8.0	0.8	1.9	43.9	32.0	2.43	51.4	18.0	2.7	46.2	3.14	36.1	100.5	4.31	4.0												
	10.0	1.2	2.7	44.2	32.1	2.40	51.6	18.5	2.6	47.0	3.16	36.9	101.1	4.36	4.1												
70	6.0	0.5	1.2	41.8	31.2	2.71	50.2	15.4	3.1	49.9	3.23	39.5	103.0	4.52	4.1												
	8.0	0.8	1.8	42.3	31.4	2.65	50.5	16.0	2.9	51.5	3.27	41.0	104.0	4.60	4.4												
	10.0	1.1	2.5	42.7	31.5	2.61	50.7	16.4	2.9	52.5	3.31	41.9	104.7	4.65	4.5												
80	6.0	0.5	1.1	40.2	30.6	2.95	49.3	13.6	3.5	55.2	3.38	44.3	106.5	4.78	4.5												
	8.0	0.8	1.8	40.7	30.8	2.87	49.6	14.2	3.2	57.0	3.44	46.0	107.7	4.86	4.8												
	10.0	1.1	2.5	41.0	30.9	2.83	49.8	14.5	3.2	58.2	3.47	47.1	108.5	4.91	4.9												
90	6.0	0.5	1.1	38.6	29.8	3.20	48.5	12.1	4.0	60.7	3.55	49.3	110.2	5.01	4.8												
	8.0	0.8	1.7	39.0	30.1	3.12	48.7	12.5	3.6	62.8	3.61	51.3	111.6	5.10	4.9												
	10.0	1.0	2.4	39.3	30.2	3.08	48.8	12.8	3.6	64.2	3.66	52.5	112.4	5.15	5.0												
100	6.0	0.5	1.1	36.9	29.1	3.47	47.7	10.6	4.7	Operation Not Recommended																	
	8.0	0.7	1.7	37.4	29.4	3.39	47.8	11.0	4.3																		
	10.0	1.0	2.3	37.7	29.5	3.35	48.0	11.2	4.2																		
110	6.0	0.5	1.0	35.2	28.6	3.79	46.9	9.3	5.3							Operation Not Recommended											
	8.0	0.7	1.7	35.7	28.8	3.69	47.1	9.7	4.9																		
	10.0	1.0	2.3	36.0	28.9	3.65	47.2	9.8	4.8																		

All Capacities in MBtuh.

Rev.: 04/02/01B

Interpolation is permissible, extrapolation is not.

All entering air conditions are 80°F DB and 67°F WB in cooling and 70°F DB in heating.

All performance data is based upon the lower voltage of dual voltage rated units.

Operation below 40°F EWT is based upon 15% antifreeze solution.

See Performance Correction Tables for operating conditions other than those listed above.

† Water pressure drop representing both circuits.

Performance Data — Ultra Classic Model 048 - Part Load

Model 048 Part Load
Rated Air Flow 880 CFM

EWT °F	GPM	WPD†		COOLING - EAT 80/67 °F						HEATING - EAT 70°F																							
		PSI	FT	TC	SC	kW	HR	EER	HWC	HC	kW	HE	LAT	COP	HWC																		
20	3.0	0.6	1.4	Operation Not Recommended																													
	4.5	1.2	2.8																														
	6.0	1.8	4.2																														
30	3.0	0.6	1.3													Operation Not Recommended						13.7	1.26	9.7	84.5	3.18	2.4						
	4.5	1.2	2.7																			15.3	1.30	11.2	86.1	3.46	2.5						
	6.0	1.7	4.0																			15.9	1.31	11.7	86.7	3.55	2.6						
40	3.0	0.6	1.3																			25.1	18.9	1.07	28.5	23.5	2.5	17.7	1.35	13.4	88.6	3.85	3.1
	4.5	1.1	2.6																			25.5	19.1	1.03	28.8	24.6	2.3	18.4	1.36	14.0	89.4	3.95	3.1
	6.0	1.7	3.9																			25.7	19.2	1.02	29.0	25.2	2.1	18.8	1.37	14.3	89.7	4.01	3.3
50	3.0	0.5	1.2	24.3	18.6	1.13	28.0	21.4	3.0	20.2	1.40	15.7	91.3	4.22	3.4																		
	4.5	1.1	2.5	24.7	18.8	1.10	28.2	22.5	2.6	21.1	1.42	16.5	92.2	4.34	3.5																		
	6.0	1.6	3.7	24.9	18.9	1.08	28.4	23.1	2.5	21.5	1.43	16.9	92.6	4.40	3.7																		
60	3.0	0.5	1.2	23.5	18.3	1.22	27.4	19.3	3.4	22.8	1.46	18.1	94.0	4.56	3.8																		
	4.5	1.1	2.4	23.9	18.4	1.17	27.7	20.4	3.0	23.8	1.49	19.0	95.0	4.68	3.9																		
	6.0	1.6	3.6	24.1	18.6	1.15	27.8	20.9	3.0	24.3	1.50	19.5	95.5	4.74	4.1																		
70	3.0	0.5	1.2	22.7	17.9	1.32	26.9	17.2	3.9	25.5	1.53	20.5	96.8	4.87	4.2																		
	4.5	1.0	2.3	23.1	18.1	1.27	27.1	18.2	3.5	26.6	1.56	21.6	98.0	5.00	4.3																		
	6.0	1.5	3.5	23.3	18.1	1.24	27.3	18.7	3.4	27.3	1.58	22.1	98.7	5.06	4.5																		
80	3.0	0.5	1.1	21.8	17.5	1.43	26.4	15.3	4.3	28.3	1.61	23.1	99.7	5.15	4.6																		
	4.5	1.0	2.3	22.2	17.8	1.38	26.6	16.1	3.9	29.6	1.64	24.3	101.1	5.27	4.7																		
	6.0	1.5	3.4	22.4	17.9	1.35	26.7	16.6	3.9	30.3	1.66	24.9	101.9	5.33	4.9																		
90	3.0	0.5	1.1	20.9	17.2	1.55	25.9	13.5	4.8	31.2	1.69	25.7	102.8	5.40	5.1																		
	4.5	0.9	2.2	21.3	17.4	1.50	26.1	14.2	4.4	32.7	1.74	27.1	104.4	5.51	5.0																		
	6.0	1.4	3.3	21.5	17.5	1.47	26.2	14.6	4.3	33.5	1.76	27.8	105.3	5.57	5.1																		
100	3.0	0.5	1.1	20.0	16.9	1.70	25.4	11.8	5.2	Operation Not Recommended																							
	4.5	0.9	2.1	20.4	17.0	1.64	25.6	12.5	4.8																								
	6.0	1.4	3.2	20.5	17.1	1.61	25.7	12.8	4.8																								
110	3.0	0.5	1.0	19.1	16.6	1.86	25.0	10.3	5.7							Operation Not Recommended																	
	4.5	0.9	2.1	19.5	16.7	1.79	25.2	10.9	5.3																								
	6.0	1.4	3.1	19.7	16.8	1.76	25.3	11.2	5.2																								

All Capacities in MBtuh.

Rev.: 04/02/01B

Interpolation is permissible, extrapolation is not.

All entering air conditions are 80°F DB and 67°F WB in cooling and 70°F DB in heating.

All performance data is based upon the lower voltage of dual voltage rated units.

Operation below 40°F EWT is based upon 15% antifreeze solution.

See Performance Correction Tables for operating conditions other than those listed above.

† Water pressure drop representing single circuit.

Performance Data — Ultra Classic Model 048 - Full Load

Model 048 Full Load
Rated Air Flow 1600 CFM

EWT °F	GPM	WPD†		COOLING - EAT 80/67 °F						HEATING - EAT 70°F											
		PSI	FT	TC	SC	kW	HR	EER	HWC	HC	kW	HE	LAT	COP	HWC						
20	6.0	0.6	1.4	Operation Not Recommended																	
	9.0	1.2	2.8																		
	12.0	1.8	4.2																		
30	6.0	0.6	1.3													31.2	2.95	21.6	88.0	3.09	2.4
	9.0	1.2	2.7													34.3	3.01	24.6	89.8	3.34	2.5
	12.0	1.7	4.0													35.6	3.04	25.7	90.6	3.43	2.6
40	6.0	0.6	1.3	36.3	3.05	26.4	91.0	3.48	2.8												
	9.0	1.1	2.6	54.1	39.3	2.46	62.2	22.0	2.5	39.3	3.11	29.2	92.7	3.70	3.1						
	12.0	1.7	3.9	55.1	39.7	2.37	62.9	23.2	2.3	40.9	3.14	30.7	93.7	3.81	3.1						
50	6.0	0.5	1.2	55.6	39.9	2.33	63.3	23.8	2.1	41.8	3.16	31.5	94.2	3.87	3.3						
	9.0	1.1	2.5	52.5	38.7	2.62	61.0	20.0	3.0	44.5	3.22	34.0	95.8	4.05	3.4						
	12.0	1.6	3.7	53.5	39.0	2.53	61.7	21.2	2.6	46.4	3.26	35.8	96.9	4.17	3.5						
60	6.0	0.5	1.2	54.0	39.2	2.48	62.1	21.7	2.5	47.5	3.28	36.8	97.5	4.23	3.7						
	9.0	1.1	2.4	50.8	37.8	2.81	59.9	18.0	3.4	49.9	3.33	39.1	98.9	4.38	3.8						
	12.0	1.6	3.6	51.8	38.4	2.70	60.5	19.1	3.0	52.2	3.39	41.2	100.2	4.51	3.9						
70	6.0	0.5	1.2	52.3	38.4	2.65	60.9	19.7	3.0	53.4	3.41	42.3	100.9	4.58	4.1						
	9.0	1.0	2.3	49.0	37.2	3.02	58.8	16.2	3.9	55.5	3.46	44.3	102.1	4.69	4.2						
	12.0	1.5	3.5	50.0	37.4	2.91	59.4	17.2	3.5	58.2	3.52	46.7	103.7	4.84	4.3						
80	6.0	0.5	1.1	50.5	37.7	2.85	59.7	17.7	3.4	59.6	3.55	48.0	104.5	4.91	4.5						
	9.0	1.0	2.3	47.2	36.4	3.27	57.7	14.4	4.3	61.3	3.59	49.6	105.5	4.99	4.6						
	12.0	1.5	3.4	48.2	36.8	3.14	58.3	15.3	3.9	64.4	3.67	52.4	107.3	5.14	4.7						
90	6.0	0.5	1.1	48.7	36.9	3.08	58.6	15.8	3.9	66.0	3.70	53.9	108.2	5.21	4.9						
	9.0	0.9	2.2	45.3	35.6	3.54	56.7	12.8	4.8	67.3	3.74	55.1	108.9	5.27	5.1						
	12.0	1.4	3.3	46.2	36.0	3.41	57.2	13.6	4.4	70.7	3.82	58.4	110.9	5.41	5.0						
100	6.0	0.5	1.1	46.7	36.3	3.34	57.4	13.9	4.3	72.6	3.87	60.0	112.0	5.49	5.1						
	9.0	0.9	2.1	43.3	34.8	3.86	55.7	11.2	5.2	Operation Not Recommended											
	12.0	1.4	3.2	44.3	35.2	3.71	56.2	11.9	4.8												
110	6.0	0.5	1.0	44.7	35.5	3.64	56.4	12.3	4.8												
	9.0	0.9	2.1	41.4	33.8	4.20	54.8	9.8	5.7												
	12.0	1.4	3.1	42.2	34.3	4.04	55.2	10.4	5.3												

All Capacities in MBtuh.

Rev.: 04/02/01B

Interpolation is permissible, extrapolation is not.

All entering air conditions are 80°F DB and 67°F WB in cooling and 70°F DB in heating.

All performance data is based upon the lower voltage of dual voltage rated units.

Operation below 40°F EWT is based upon 15% antifreeze solution.

See Performance Correction Tables for operating conditions other than those listed above.

† Water pressure drop representing both circuits.

Performance Data — Ultra Classic Model 060 - Part Load

Model 060 Part Load
Rated Air Flow 1100 CFM

EWT °F	GPM	WPD†		COOLING - EAT 80/67 °F						HEATING - EAT 70°F																	
		PSI	FT	TC	SC	kW	HR	EER	HWC	HC	kW	HE	LAT	COP	HWC												
20	3.5	0.8	1.9	Operation Not Recommended																							
	5.3	1.4	3.3																								
	7.0	2.4	5.5																								
30	3.5	0.8	1.9																			19.3	1.93	12.7	86.3	2.93	2.6
	5.3	1.4	3.2																			20.9	1.96	14.2	87.6	3.13	3.0
	7.0	2.3	5.4																			21.8	1.98	15.1	88.4	3.23	3.0
40	3.5	0.8	1.8													34.7	26.3	1.58	39.5	22.0	2.6	23.8	2.01	17.0	90.1	3.47	3.3
	5.3	1.3	3.1													35.4	26.6	1.50	40.0	23.5	2.4	24.9	2.03	18.0	91.0	3.59	3.4
	7.0	2.2	5.2													35.8	26.6	1.47	40.3	24.4	2.3	25.5	2.04	18.5	91.5	3.66	3.4
50	3.5	0.8	1.7													33.6	25.9	1.71	38.8	19.7	3.1	26.8	2.06	19.8	92.6	3.81	3.7
	5.3	1.3	3.0	34.3	26.0	1.62	39.3	21.2	2.8	28.1	2.08	21.0	93.6	3.96	3.7												
	7.0	2.2	5.0	34.7	26.2	1.58	39.5	21.9	2.6	28.9	2.10	21.7	94.3	4.03	3.9												
60	3.5	0.7	1.7	32.5	25.5	1.86	38.2	17.5	3.7	30.0	2.11	22.8	95.2	4.17	4.0												
	5.3	1.3	2.9	33.1	25.7	1.76	38.5	18.8	3.5	31.5	2.14	24.2	96.5	4.32	4.1												
	7.0	2.1	4.9	33.5	25.7	1.72	38.8	19.5	3.2	32.4	2.15	25.0	97.2	4.41	4.2												
70	3.5	0.7	1.6	31.4	24.9	2.02	37.6	15.5	4.3	33.3	2.16	25.9	98.0	4.51	4.4												
	5.3	1.2	2.8	32.0	25.3	1.92	37.9	16.6	4.1	35.0	2.18	27.6	99.5	4.70	4.5												
	7.0	2.0	4.6	32.4	25.4	1.88	38.1	17.2	3.7	36.0	2.20	28.5	100.3	4.79	4.8												
80	3.5	0.7	1.6	30.2	24.4	2.21	37.0	13.7	4.9	36.6	2.21	29.1	100.8	4.86	4.8												
	5.3	1.2	2.7	30.9	24.7	2.10	37.4	14.7	4.6	38.6	2.24	31.0	102.5	5.05	4.9												
	7.0	2.0	4.5	31.1	24.9	2.05	37.5	15.2	4.4	39.8	2.26	32.1	103.5	5.17	5.0												
90	3.5	0.7	1.5	29.0	23.9	2.42	36.5	12.0	5.5	40.2	2.26	32.5	103.9	5.22	4.8												
	5.3	1.1	2.6	29.6	24.3	2.31	36.7	12.8	5.2	42.5	2.29	34.7	105.8	5.44	4.9												
	7.0	1.9	4.3	30.0	24.3	2.25	36.9	13.3	5.1	43.7	2.30	35.9	106.8	5.57	5.0												
100	3.5	0.6	1.5	27.7	23.3	2.66	36.0	10.4	6.1	Operation Not Recommended																	
	5.3	1.1	2.6	28.3	23.7	2.54	36.2	11.2	5.8																		
	7.0	1.8	4.3	28.7	23.7	2.48	36.4	11.6	5.7																		
110	3.5	0.6	1.5	26.4	22.9	2.93	35.5	9.0	6.8																		
	5.3	1.1	2.5	27.0	23.2	2.80	35.7	9.7	6.4																		
	7.0	1.8	4.2	27.4	23.2	2.73	35.9	10.0	6.3																		

All Capacities in MBtuh.

Rev.: 04/02/01B

Interpolation is permissible, extrapolation is not.

All entering air conditions are 80°F DB and 67°F WB in cooling and 70°F DB in heating.

All performance data is based upon the lower voltage of dual voltage rated units.

Operation below 40°F EWT is based upon 15% antifreeze solution.

See Performance Correction Tables for operating conditions other than those listed above.

† Water pressure drop representing single circuit.

Performance Data — Ultra Classic Model 060 - Full Load

Model 060 Full Load
Rated Air Flow 2000 CFM

EWT °F	GPM	WPD†		COOLING - EAT 80/67 °F						HEATING - EAT 70°F											
		PSI	FT	TC	SC	kW	HR	EER	HWC	HC	kW	HE	LAT	COP	HWC						
20	7.0	0.8	1.9	Operation Not Recommended																	
	10.5	1.4	3.3																		
	14.0	2.4	5.5																		
30	7.0	0.8	1.9													39.7	4.23	25.3	88.4	2.75	2.6
	10.5	1.4	3.2													42.9	4.29	28.3	89.9	2.93	3.0
	14.0	2.3	5.4													44.7	4.32	30.0	90.7	3.03	3.0
40	7.0	0.8	1.8	45.7	4.34	30.9	91.2	3.09	3.1												
	10.5	1.3	3.1	67.4	49.0	3.48	78.1	19.4	2.6	48.7	4.39	33.7	92.5	3.25	3.3						
	14.0	2.2	5.2	68.7	49.6	3.33	79.0	20.6	2.4	50.8	4.44	35.7	93.5	3.35	3.4						
50	7.0	0.8	1.7	69.4	49.9	3.26	79.4	21.3	2.3	52.0	4.46	36.8	94.1	3.42	3.4						
	10.5	1.3	3.0	65.2	48.2	3.74	76.8	17.4	3.1	54.6	4.50	39.3	95.3	3.56	3.7						
	14.0	2.2	5.0	66.6	48.7	3.57	77.6	18.6	2.8	57.2	4.55	41.6	96.5	3.68	3.7						
60	7.0	0.7	1.7	67.4	48.7	3.49	78.2	19.3	2.6	58.6	4.58	42.9	97.1	3.75	3.9						
	10.5	1.3	2.9	63.1	47.0	4.03	75.6	15.7	3.7	61.0	4.62	45.2	98.2	3.87	4.0						
	14.0	2.1	4.9	64.4	47.6	3.85	76.4	16.7	3.5	64.0	4.68	48.0	99.6	4.00	4.1						
70	7.0	0.7	1.6	65.0	48.0	3.76	76.6	17.3	3.2	65.6	4.71	49.5	100.4	4.08	4.2						
	10.5	1.2	2.8	60.7	46.3	4.37	74.2	13.9	4.3	67.4	4.74	51.3	101.2	4.17	4.4						
	14.0	2.0	4.6	62.0	46.8	4.17	74.9	14.9	4.1	70.7	4.73	54.6	102.7	4.38	4.5						
80	7.0	0.7	1.6	62.8	46.9	4.08	75.4	15.4	3.7	72.8	4.83	56.3	103.7	4.42	4.8						
	10.5	1.2	2.7	58.4	45.1	4.74	73.2	12.3	4.9	74.1	4.85	57.6	104.3	4.48	4.8						
	14.0	2.0	4.5	59.7	45.6	4.53	73.8	13.2	4.6	78.1	4.91	61.3	106.1	4.66	4.9						
90	7.0	0.7	1.5	60.4	45.9	4.43	74.1	13.6	4.4	80.3	4.94	63.4	107.2	4.76	5.0						
	10.5	1.1	2.6	56.1	44.2	5.17	72.3	10.9	5.5	81.1	4.95	64.2	107.5	4.80	4.8						
	14.0	1.9	4.3	57.3	45.0	4.94	72.7	11.6	5.2	85.7	5.03	68.5	109.7	4.99	4.9						
100	7.0	0.6	1.5	57.9	45.0	4.83	72.9	12.0	5.1	88.1	5.06	70.9	110.8	5.11	5.0						
	10.5	1.1	2.6	53.7	43.2	5.64	71.3	9.5	6.1	Operation Not Recommended											
	14.0	1.8	4.3	54.8	44.0	5.40	71.7	10.2	5.8												
110	7.0	0.6	1.5	55.5	44.0	5.28	72.0	10.5	5.7												
	10.5	1.1	2.5	51.1	42.4	6.17	70.4	8.3	6.8												
	14.0	1.8	4.2	52.4	42.7	5.91	70.9	8.9	6.4												

All Capacities in MBtuh.

Rev.: 04/02/01B

Interpolation is permissible, extrapolation is not.

All entering air conditions are 80°F DB and 67°F WB in cooling and 70°F DB in heating.

All performance data is based upon the lower voltage of dual voltage rated units.

Operation below 40°F EWT is based upon 15% antifreeze solution.

See Performance Correction Tables for operating conditions other than those listed above.

† Water pressure drop representing both circuits.

Performance Data — Ultra Classic Model 072 - Part Load

Model 072 Part Load
Rated Air Flow 1210 CFM

EWT °F	GPM	WPD†		COOLING - EAT 80/67 °F						HEATING - EAT 70°F																	
		PSI	FT	TC	SC	kW	HR	EER	HWC	HC	kW	HE	LAT	COP	HWC												
20	3.5	0.8	1.9	Operation Not Recommended																							
	5.3	1.4	3.3																								
	7.0	2.4	5.5																								
30	3.5	0.8	1.9																			22.5	2.09	15.3	87.2	3.15	3.1
	5.3	1.4	3.2																			24.0	2.11	16.8	88.4	3.33	3.6
	7.0	2.3	5.4																			25.1	2.13	17.9	89.2	3.46	3.6
40	3.5	0.8	1.8													38.7	29.0	1.80	44.8	21.5	3.1	27.1	2.16	19.7	90.7	3.67	4.0
	5.3	1.3	3.1													39.6	29.2	1.74	45.1	22.8	2.9	28.4	2.18	21.0	91.8	3.82	4.0
	7.0	2.2	5.2													40.0	29.4	1.68	45.4	23.8	2.8	29.2	2.20	21.7	92.3	3.89	4.1
50	3.5	0.8	1.7													37.5	28.4	2.01	43.9	18.7	3.7	30.4	2.21	22.8	93.2	4.02	4.4
	5.3	1.3	3.0													38.4	28.7	1.89	44.4	20.3	3.4	32.0	2.24	24.3	94.5	4.18	4.5
	7.0	2.2	5.0													38.8	28.9	1.84	44.6	21.1	3.1	32.9	2.26	25.2	95.2	4.27	4.6
60	3.5	0.7	1.7	36.3	27.8	2.18	43.2	16.6	4.4	33.8	2.27	26.1	95.9	4.37	4.8												
	5.3	1.3	2.9	37.1	28.2	2.06	43.6	18.0	4.1	35.7	2.30	27.9	97.3	4.55	4.9												
	7.0	2.1	4.9	37.5	28.4	2.01	43.9	18.7	3.8	36.8	2.32	28.9	98.2	4.65	5.0												
70	3.5	0.7	1.6	35.0	27.2	2.37	42.5	14.7	5.1	37.5	2.29	29.7	98.7	4.80	5.3												
	5.3	1.2	2.8	35.8	27.6	2.25	42.9	15.9	4.9	39.9	2.37	31.8	100.5	4.93	5.4												
	7.0	2.0	4.6	36.2	27.9	2.19	43.1	16.5	4.4	41.0	2.39	32.8	101.3	5.02	5.7												
80	3.5	0.7	1.6	33.6	26.9	2.60	41.9	12.9	5.9	41.2	2.39	33.1	101.5	5.05	5.7												
	5.3	1.2	2.7	34.5	27.1	2.46	42.3	14.0	5.5	43.8	2.44	35.5	103.5	5.26	5.9												
	7.0	2.0	4.5	34.9	27.3	2.39	42.5	14.5	5.2	45.3	2.47	36.8	104.6	5.37	6.0												
90	3.5	0.7	1.5	32.3	26.3	2.86	41.4	11.3	6.6	45.9	2.64	36.9	105.1	5.09	5.7												
	5.3	1.1	2.6	33.1	26.6	2.71	41.7	12.2	6.2	49.0	2.70	39.8	107.5	5.32	5.9												
	7.0	1.9	4.3	33.4	26.8	2.63	41.8	12.7	6.1	50.6	2.73	41.3	108.8	5.44	6.0												
100	3.5	0.6	1.5	30.8	25.8	3.16	40.9	9.8	7.3	Operation Not Recommended																	
	5.3	1.1	2.6	31.6	26.0	2.99	41.2	10.6	7.0																		
	7.0	1.8	4.3	32.0	26.2	2.91	41.3	11.0	6.8																		
110	3.5	0.6	1.5	29.3	25.4	3.54	40.6	8.3	8.2																		
	5.3	1.1	2.5	30.2	25.5	3.32	40.7	9.1	7.7																		
	7.0	1.8	4.2	30.6	25.6	3.23	40.9	9.5	7.5																		

All Capacities in MBtuh.

Rev.: 04/02/01B

Interpolation is permissible, extrapolation is not.

All entering air conditions are 80°F DB and 67°F WB in cooling and 70°F DB in heating.

All performance data is based upon the lower voltage of dual voltage rated units.

Operation below 40°F EWT is based upon 15% antifreeze solution.

See Performance Correction Tables for operating conditions other than those listed above.

† Water pressure drop representing single circuit.

Performance Data — Ultra Classic Model 072 - Full Load

Model 072 Full Load
Rated Air Flow 2130 CFM

EWT °F	GPM	WPD†		COOLING - EAT 80/67 °F						HEATING - EAT 70°F																	
		PSI	FT	TC	SC	kW	HR	EER	HWC	HC	kW	HE	LAT	COP	HWC												
20	7.0	0.8	1.9	Operation Not Recommended																							
	10.5	1.4	3.3																								
	14.0	2.4	5.5																								
30	7.0	0.8	1.9																			46.5	4.72	30.4	90.2	2.89	3.1
	10.5	1.4	3.2																			49.6	4.78	33.3	91.5	3.04	3.6
	14.0	2.3	5.4																			51.8	4.82	35.4	92.5	3.15	3.6
40	7.0	0.8	1.8													75.0	53.2	4.16	88.3	18.0	3.1	55.7	4.89	39.0	94.2	3.34	4.0
	10.5	1.3	3.1													76.7	53.9	3.95	89.3	19.4	2.9	58.4	4.93	41.5	95.4	3.47	4.0
	14.0	2.2	5.2													77.3	54.5	3.85	89.7	20.1	2.8	59.9	4.96	43.0	96.0	3.54	4.1
50	7.0	0.8	1.7	72.5	52.2	4.48	86.9	16.2	3.7	62.3	5.00	45.2	97.1	3.65	4.4												
	10.5	1.3	3.0	74.0	53.2	4.27	87.7	17.4	3.4	65.4	5.06	48.2	98.4	3.79	4.5												
	14.0	2.2	5.0	74.9	53.5	4.16	88.2	18.0	3.1	67.3	5.09	49.9	99.2	3.87	4.6												
60	7.0	0.7	1.7	69.9	51.5	4.84	85.3	14.4	4.4	69.2	5.12	51.7	100.1	3.96	4.8												
	10.5	1.3	2.9	71.7	51.8	4.60	86.4	15.6	4.1	72.9	5.20	55.2	101.7	4.11	4.9												
	14.0	2.1	4.9	72.5	52.2	4.49	86.9	16.2	3.8	75.1	5.24	57.2	102.6	4.20	5.0												
70	7.0	0.7	1.6	67.3	50.4	5.23	84.0	12.9	5.1	76.3	5.26	58.4	103.2	4.25	5.3												
	10.5	1.2	2.8	68.9	51.1	4.98	84.8	13.8	4.9	80.8	5.35	62.5	105.1	4.42	5.4												
	14.0	2.0	4.6	69.7	51.3	4.86	85.3	14.4	4.4	83.2	5.39	64.8	106.2	4.52	5.7												
80	7.0	0.7	1.6	64.7	49.4	5.68	82.8	11.4	5.9	83.9	5.41	65.4	106.5	4.54	5.7												
	10.5	1.2	2.7	66.3	50.0	5.40	83.5	12.3	5.5	89.0	5.51	70.1	108.7	4.73	5.9												
	14.0	2.0	4.5	67.0	50.3	5.28	83.9	12.7	5.2	91.8	5.57	72.8	109.9	4.83	6.0												
90	7.0	0.7	1.5	62.1	48.0	6.19	81.9	10.0	6.6	91.8	5.58	72.7	109.9	4.82	5.7												
	10.5	1.1	2.6	63.6	48.8	5.89	82.4	10.8	6.2	97.5	5.70	78.0	112.4	5.01	5.9												
	14.0	1.9	4.3	64.3	49.1	5.75	82.7	11.2	6.1	100.7	5.78	80.9	113.8	5.10	6.0												
100	7.0	0.6	1.5	59.3	47.2	6.80	81.0	8.7	7.3	Operation Not Recommended																	
	10.5	1.1	2.6	60.8	47.8	6.45	81.4	9.4	7.0																		
	14.0	1.8	4.3	61.6	48.0	6.30	81.7	9.8	6.8																		
110	7.0	0.6	1.5	56.5	46.0	7.48	80.5	7.5	8.2																		
	10.5	1.1	2.5	58.0	46.6	7.11	80.7	8.2	7.7																		
	14.0	1.8	4.2	58.7	47.0	6.94	80.9	8.5	7.5																		

All Capacities in MBtuh.

Rev.: 04/02/01B

Interpolation is permissible, extrapolation is not.

All entering air conditions are 80°F DB and 67°F WB in cooling and 70°F DB in heating.

All performance data is based upon the lower voltage of dual voltage rated units.

Operation below 40°F EWT is based upon 15% antifreeze solution.

See Performance Correction Tables for operating conditions other than those listed above.

† Water pressure drop representing both circuits.

Dimensions — Vertical Topflow Ultra Classic

Standard Deluxe Filter Rack Dimensions

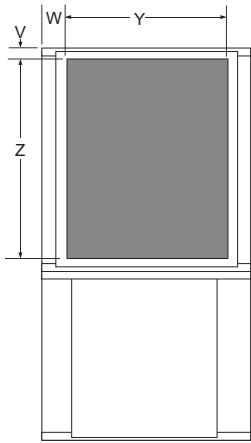

Note: Filter Rack extends out from cabinet 2.75"

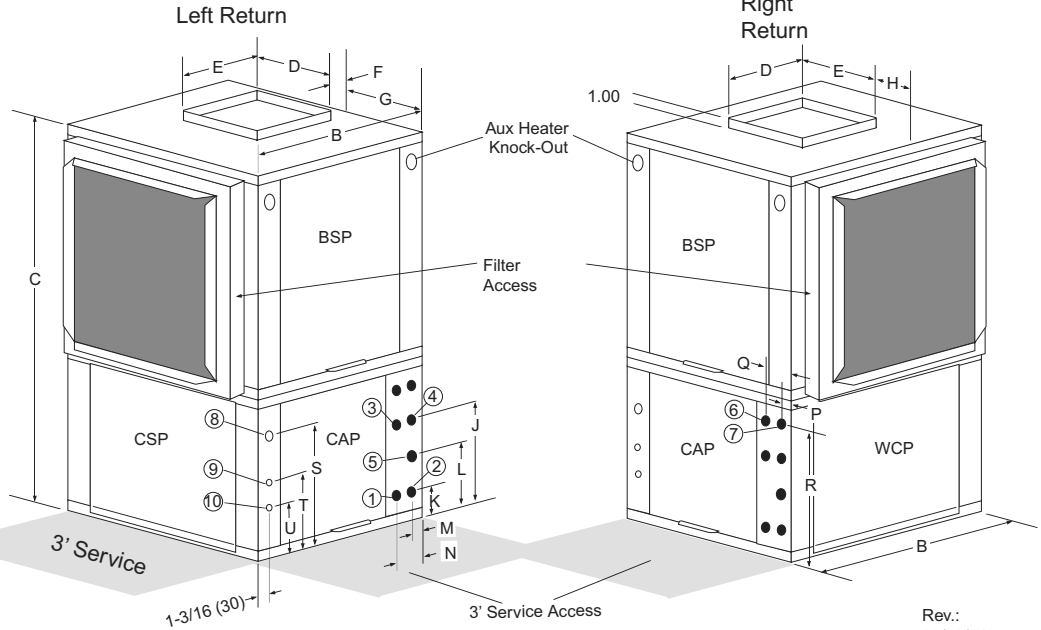

Rev.: 03/30/01B

Legend

- 1 Water Inlet for Circuit A - 1" FPT Swivel Connection
- 2 Water Inlet for Circuit B - 1" FPT Swivel Connection
- 3 Water Outlet for Circuit A - 1" FPT Swivel Connection
- 4 Water Outlet for Circuit B - 1" FPT Swivel Connection
- 5 Condensate - 3/4" FPT Connection
- 6 Hot Water Generator Inlet for Circuit A - 1/2" FPT
- 7 Hot Water Generator Outlet for Circuit A - 1/2" FPT
- 8 Low voltage thermostat knockout for 1/2" conduit
- 9 External Pump Power In knockout for 1/2" conduit
- 10 Unit power knockout for 3/4" conduit

Abbreviations

- CAP** Control Access Panel
BSP Blower Service panel
CSP Compressor Service panel
WCP Water Circuit Access Panel

Model	Overall Cabinet			Discharge Connection duct flange installed (±0.10 in)				Water Connections						Electrical Knockouts			Return Connection using std deluxe filter rack (±0.10 in)							
	A Width	B Depth	C Height	D Supply Depth	E Supply Width	F	G	H	Water and Condensate				Hot Water Generator		S Power Supply	T Ext Pump	U Low Voltage	V	W	Y Return Width	Z Return Height			
									J Water Out	K Water In	L Condensate	M	N	P								Q	R HWG	
036	inches 635	25 635	25 1308	51 1/2 1308	13 15/16 354	13 15/16 354	1	5 1/2 140	5 127	14 356	2 7/8 73	8 7/8 225	2 1/2 64	5 1/2 140	1 3/4 44	6 152	22 5/8 575	12 1/8 308	9 5/8 244	8 203	2 51	1 7/8 48	21 3/4 552	21 3/4 552
042	inches 714	28 1/8 714	28 1/8 1511	59 1/2 1511	17 15/16 456	17 15/16 456	2 5/8 67	5 127	5 1/8 130	17 5/8 448	2 7/8 73	8 7/8 225	2 1/8 54	5 3/4 146	1 1/2 38	6 1/4 159	22 5/8 575	12 1/8 308	9 5/8 244	8 203	2 51	1 7/8 48	24 5/8 626	29 3/8 746
048	inches 714	28 1/8 714	28 1/8 1511	59 1/2 1511	17 15/16 456	17 15/16 456	2 5/8 67	5 127	5 1/8 130	17 5/8 448	2 7/8 73	8 7/8 225	2 1/8 54	5 3/4 146	1 1/2 38	6 1/4 159	22 5/8 575	12 1/8 308	9 5/8 244	8 203	2 51	1 7/8 48	24 5/8 626	29 3/8 746
060	inches 714	28 1/8 714	28 1/8 1610	63 3/8 1610	17 15/16 456	17 15/16 456	2 5/8 67	5 127	5 1/8 130	17 5/8 448	2 7/8 73	8 7/8 225	2 1/8 54	5 3/4 146	1 1/2 38	6 1/4 159	22 5/8 575	12 1/8 308	9 5/8 244	8 203	2 51	1 7/8 48	24 5/8 626	33 3/8 848
072	inches 714	28 1/8 714	28 1/8 1610	63 3/8 1610	17 15/16 456	17 15/16 456	2 5/8 67	5 127	5 1/8 130	17 5/8 448	2 7/8 73	8 7/8 225	2 1/8 54	5 3/4 146	1 1/2 38	6 1/4 159	22 5/8 575	12 1/8 308	9 5/8 244	8 203	2 51	1 7/8 48	24 5/8 626	33 3/8 848

Vertical unit shipped with deluxe duct collar/filter rack extending from unit 2.75" and is suitable for duct connection.
 Discharge flange is field installed

Rev.: 11/2001 b

Electrical Data — Ultra Classic

Model	Compressor				Fan Motor HP	Fan Motor FLA	HWG Pump Amps	Loop Pump Amps	Total FLA Amps	Minimum Circuit Ampacity	Max Fuse USA	Max Fuse Can	Min Wire AWG	Maximum Wire Length (ft.)
	Sys A		Sys B											
	RLA	LRA	RLA	LRA										
036	7.1	38	7.1	38	1/2	4.3	0.4	4.0	22.9	24.7	30	30	10	70
042	10.0	42	10.7	47	1/2	4.3	0.4	4.0	29.4	32.1	40	40	8	90
048	10.7	47	11.4	54	1.0	7.0	0.4	4.0	33.5	36.3	45	45	6	120
060	13.6	67	13.6	67	1.0	7.0	0.4	4.0	38.6	42.0	50	50	6	110
072	15.0	73	15.0	73	1.0	7.0	0.4	4.0	41.4	45.2	50	50	6	100

All units rated Voltage of 208-230/60/1.

All units Min/Max Voltage of 187/253.

HACR breaker in USA only. All fuses Class RK-5.

Wire length based on one way measurement with 2% Voltage drop and wire size based upon 60°C copper conductors.

Rev.: 03/30/01B

Physical Data

MODEL	036	042	048	060	072
Fan Wheel (Dia. X Width), in.	9 X 7	11 X 10		11 X 10	
Fan Motor & HP	ICM2 - 1/2	ICM2 - 1/2	ICM2 - 1	ICM2 - 1	
No. Refrigerant Circuits	2	2	2	2	2
Compressors	2 - Rotary	2 - Scroll		2 - Scroll	
No. Coaxial Heat Exchangers	2	2	2	2	2
R - 22 Charge (Sys A / Sys B), oz	40 / 40	57 / 59	62 / 62	54 / 54	58 / 58
Water Connection Size (fpt swivel)	1"	1"	1"	1"	1"
Air Coil Length x Height, in.	20 X 24	24 X 24	24 X 32	24 X 36	24 X 36
Filter - 1" ElectroStatic (Std.)	24 x 24	27 x 31	27 x 31	27 x 35	27 x 35
Weight - Operating (lbs.)	225	275	305	385	450
Weight - Packaged (lbs.)	235	285	315	395	460

All units have txv expansion devices, 20 ga sheet metal, and 7/8" & 1-1/8" electrical knockouts.

All units have dual 1" Swivel water connections (4 total)

HWG utilizes 1/2" fpt water connections and is available only on circuit A.

All units have 3/4" fpt condensate drain connections.

Rev.: 8/07/04D

Revision

Data from Tom North 9/00

Date

10/30/00

Ultra Classic ICM Control Features

Air Flow Selection

Air flow selection is accomplished via 3 jumper switches on the ICM2 control board. Actual airflow is indicated by the CFM LED with each 100 CFM being represented by one flash of the LED. Refer to the Ultra Classic ICM airflow table for detailed information on air flow choices. Air flow is automatically maintained ($\pm 5\%$) by the ICM2 motor regardless of external static pressure up to its maximum output capacity.

ICM2 Control Board

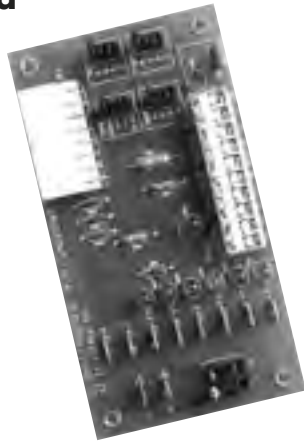

- Airflow selection
- Dehumidification mode
- CFM LED
- Thermostat diagnostic LEDs

ICM2 Control Board Field Selection Jumpers

Dehumidification Jumper - This jumper allows the selection of dehumidification mode which reduces airflow in cooling by 25% to increase the moisture removal capacity of the unit. This mode should not be selected if the 'HP CFM' is on setting 1.

Fan Speed Selection Jumper 'HP CFM' - This jumper provides a 'rough' selection of airflow. 4 is the highest airflow and 1 is the lowest airflow setting.

Fan Speed Selection Jumper 'CFM ADJ' - This jumper provides a 'fine' selection of airflow for the unit. CFM ADJ + increases airflow, CFM ADJ - decreases airflow and CFM Normal is the factory position.

Fan Speed Selection Jumper 'AUX CFM' - This jumper provides airflow selection during auxiliary heating. The auxiliary heat airflow will be the higher of the 'HP CFM' or 'AUX CFM' settings. Four (4) is the highest airflow and 1 is the lowest airflow setting.

Fan Delay Selection Jumper 'DELAY' - This jumper is for factory use and the factory setting is 4.

Note: To achieve full benefit of the ICM blower a 3 Heat / 2 Cool ATA32H01 thermostat should be employed. The first two stages of thermostats call for fan speed changes.

Ultra Classic Blower Performance Data

Model	Max ESP (in wg)	Fan Motor (hp)	HP CFM Setting	Normal Mode Htg & Normal Clg			Dehumid Mode Dehumid Clg			Aux CFM Setting	Aux Emerg Mode
				Stg 2	Stg 1	Fan	Stg 2	Stg 1	Fan		
				4	3	2	1	4	3		
036	0.5	1/2	4	1290	710	650	1010	550	650	4	1290
			3	1200	660	600	940	520	600	3	1200
			2	1110	610	560	870	480	560	2	1110
			1	1020	560	510	800	440	510	1	1020
042	0.5	1/2	4	1450	800	730	1130	620	730	4	1450
			3	1400	770	700	1090	600	700	3	1400
			2	1300	720	650	1010	560	650	2	1300
			1	1190	660	600	930	510	600	1	1190
048	0.75	1	4	1720	950	860	1340	740	860	4	1720
			3	1600	880	800	1250	690	800	3	1600
			2	1480	810	740	1150	630	740	2	1480
			1	1360	750	680	1060	590	680	1	1360
060	0.75	1	4	2150	1180	1080	1680	920	1080	4	2150
			3	2000	1100	1000	1560	860	1000	3	2000
			2	1850	1020	930	1440	800	930	2	1850
			1	1700	940	850	1330	730	850	1	1700
072	0.75	1	4	2250	1280	1130	1760	1000	1130	4	2250
			3	2130	1210	1070	1660	940	1070	3	2130
			2	2000	1140	1000	1560	890	1000	2	2000
			1	1900	1080	950	1480	840	950	1	1900

Bold figures indicate factory settings, setting (3) on all models.

Rev.: 05/11/01B

These values represent Left return models. For right return units move the CFM adj from (norm) to the (+) setting.

During Auxiliary operation the CFM will run at the higher of the HP or AUX settings.

Airflow is controlled within $\pm 5\%$ up to Max ESP shown with wet coil and with 1" throwaway filter.

Standard 1" electrostatic filter will add 0.15 in wg when clean.

When Dehumidification mode is selected, HP CFM setting must be 4, 3, or 2 only.

All units ARI/ISO/ASHRAE 13256-1 rated at maximum external static.

Thermostat Features and Wiring

ATA32H01 - Auto Changeover electronic 3 Heat / 2 Cool thermostat

This electronic thermostat is suited to all Ultra Classic applications.

The Ultra Classic also employs an ICM2 board that features:

- Thermostat terminal connections
- Thermostat signal diagnostic LED's
- Airflow selection
- Airflow LED (100 CFM per flash)
- Dehumidification mode jumper

ATA32H01 wiring

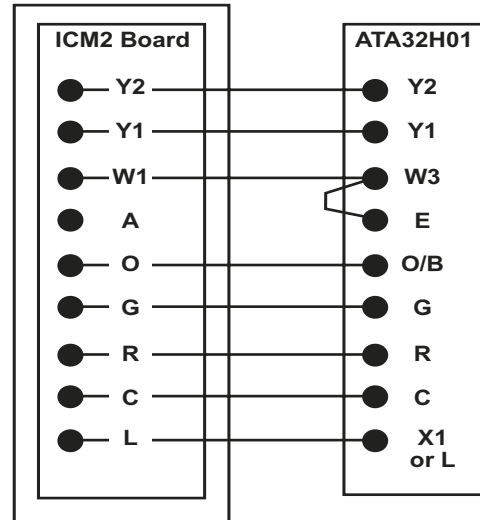

Note: E & W3 must be jumpered.

Ultra Classic CXM Control Features

Features

- Anti-short Cycle Protection
- High And Low Pressure Cuts
- Water Coil Freeze Protection
- Air Coil Freeze Protection
- Random Start
- Unit Performance Sentinel
- Over/Under Voltage Protection
- Diagnostic LED
- Reset Lockout at Unit or Disconnect
- Intelligent Reset
- Condensate Overflow Sensor
- Test Mode
- Electric Heat Outputs
- Accessory Water Valve Connection
- Optional Lonworks Control

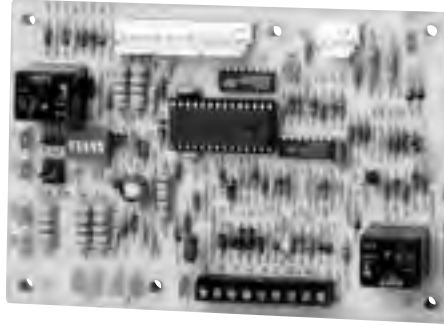

Field Selectable Inputs

Test Mode - Test Mode allows the service personnel to check the operation of the control in a timely manner. By **momentarily** shorting the test terminals, the CXM control enters a 20 minute Test Mode period in which all time delays are sped up 15 times. Upon entering Test Mode, the Status LED will flash a code representing the last fault. For Diagnostic ease at the thermostat, the alarm relay will also cycle during test mode. The Alarm relay will cycle on and off, similar to the status LED, to indicate a code representing the last fault, at the thermostat. Test mode can be exited by shorting the test terminals for 3 seconds.

Retry Mode - If the control is attempting a retry of a fault, the status LED will slow flash (slow flash=one flash every 2 seconds) to indicate the control is in process of retrying.

Note: In the following field configuration options, jumper wires should be clipped ONLY when power is removed from the CXM control.

Water Coil Freeze Protection Limit Setting - Jumper 2 (JW2-F12 Low Temp) provides field selection of temperature limit setting for FP1 to be 30°F or 10°F. Not Clipped=30°F. Clipped=10°F.

Air Coil Freeze Protection Limit Setting - Jumper 3 (JW3-FP2 Low Temp) provides field selection of temperature limit setting for FP2 to be 30°F or 10°F. Not Clipped=30°F. Clipped=10°F.

Alarm Relay Setting - Jumper 1 (JW1-AL2 Dry) provides field selection of Alarm Relay terminal AL2 to be jumpered to 24Vac or to be dry (no connection). Not Clipped=AL2 connected to R. Clipped=AL2 dry contacts (no connection).

DIP Switches

Unit Performance Sentinel Disable - Dip Switch 1 provides field selection to disable The UPS feature. On = Enabled. Off = Disabled.

Stage 2 - Dip Switch 2 provides selection of whether compressor has an on delay. If set to stage 2, the compressor will have a 3 second delay before energizing. Also, if set for stage 2, the alarm relay will NOT cycle during test mode. On = Stage 1. Off = Stage 2.

Safety Features

The following safety features are provided to protect the compressor, heat exchangers, wiring, and other components from damage caused by operation outside of design conditions.

Anti-Short Cycle Protection- The control features a 5-minute anti-short cycle protection for the compressor. **Note: The 5 minute anti-short cycle also occurs at power up.**

Random Start - The control features a random start upon power up from 5-80 seconds.

Fault Retry - In Fault Retry mode, the Status LED begins slow flashing to signal that the control is trying to recover from a fault input.

The CXM control will stage off the outputs and then “try again” to satisfy the thermostat “Y” input call. Once the thermostat input calls are satisfied, the control will continue on as if no fault occurred. If 3 consecutive faults occur without satisfying the thermostat “Y” input call, then the control will go to Lockout mode. The last fault causing the lockout will be stored in memory and can be viewed by going into test mode.

Lockout - In Lockout mode, the Status LED will begin fast flashing. The compressor relay is turned off immediately. Lockout mode can be soft reset via the thermostat “Y” input or can be hard reset via the disconnect. The last fault causing the lockout will be stored in memory and can be viewed by going into test mode.

Lockout with Emergency Heat - While in Lockout mode, if W becomes active, then Emergency Heat mode will occur.

High Pressure Switch - When the High Pressure Switch opens due to high refrigerant pressures, the Compressor relay is de-energized immediately since the High Pressure Switch is in series with the compressor contactor coil. The High Pressure Fault recognition is immediate as well. High Pressure Lockout Code = 2. Example: 2 quick flashes, 10 sec. pause, 2 quick flashes, 10 sec. pause, etc.

Low Pressure Switch - The Low Pressure Switch must be open and remain open for 30 continuous seconds during “on” cycle to be recognized as a Low Pressure fault. If the low pressure switch is open for 30 seconds prior to compressor power up it will be considered a low pressure (loss of charge) fault. The Low Pressure Switch input is bypassed for the initial 60 seconds of a compressor run cycle. Low Pressure Lockout Code = 3.

Water Coil Freeze Protection (FP1) - The FP1 thermistor temperature must be below the selected freeze protection limit setting for 30 continuous seconds during a compressor run cycle to be recognized as a FP1 fault. The FP1 input is bypassed for the initial 60 seconds of a compressor run cycle. FP1 Lockout Code = 4.

Air Coil Freeze Protection (FP2) - The FP2 thermistor temperature must be below the selected freeze protection limit setting for 30 continuous seconds during a compressor run cycle to be recognized as a FP2 fault. The FP2 input is bypassed for the initial 60 seconds of a compressor run cycle. FP2 Lockout Code = 5.

CXM Control Features Cont....

Condensate Overflow - The Condensate Overflow sensor must sense overflow levels for 30 continuous seconds to be recognized as a CO fault. Condensate Overflow will be monitored at all times. CO Lockout Code = 6.

Over/Under Voltage Shutdown - An Over/Under Voltage condition exists when the control voltage is outside the range of 19Vac to 30Vac. Over/Under Voltage Shutdown is self-resetting in that if the voltage comes back within range of 19Vac to 30Vac for at least 0.5 seconds, then normal operation is restored. This is not considered a fault or lockout. If the CXM is in over/under voltage shutdown for 15 minutes, the alarm relay will close. Over/Under Voltage Shutdown Code = 7.

Unit Performance Sentinel-UPS (patent pending) - The UPS feature warns when the heat pump is operating inefficiently. A UPS condition exists when:

- a) in heating mode with compressor energized, if FP2 is greater than 125°F for 30 continuous seconds,

or

- b) in cooling mode with compressor energized, if FP1 is greater than 125°F for 30 continuous seconds, OR FP2 is less than 40°F for 30 continuous seconds.

If a UPS condition occurs, the control will immediately go to UPS warning. The status LED will remain on as if the control is on Normal mode (see "LED and Alarm Relay Operation Table"). Outputs of the control, excluding LED and Alarm Relay, will NOT be affected by UPS. The UPS condition cannot occur during a compressor off cycle. During UPS warning, the alarm relay will cycle on and off. The cycle rate will be On for 5 seconds, Off for 25 seconds, On for 5 seconds, Off for 25 seconds, etc. Unit Performance Sentinel Warning Code = 8.

Diagnostic Features

The Status LED on the CXM control advises the serviceman of the current status of the CXM control. The status LED can display either the current CXM mode or the last fault memory if in test mode. See Table 1 for a complete listing of codes.

Unit Operation Description

PowerUp - The unit will not operate until all the inputs and safety controls are checked for normal conditions.

Note: The compressor will have a 5-minute anti-short -cycle delay at power-up.

Standby - In Standby mode, Y and W inputs are not active. Inputs O and G may be active. Compressor will be off.

Cooling - To enter Cooling mode, Y and O become active. The first time after power-up that there is a call for compressor, the compressor will follow a 5 to 80 second random start delay. There will also be a 5-minute compressor anti-short cycle protection time as well. After the random start delay, the compressor relay is energized. On all subsequent compressor calls, the random start delay is omitted.

Heating Stage 1 - To enter Heating Stage 1 mode, Y becomes active. The first time after power-up that there is a call for compressor, the compressor will follow a 5 to 80 second random start delay. There will also be a 5-minute compressor anti-short cycle protection time as well. After the random start delay, the compressor relay is energized. On all subsequent compressor calls, the random start delay is omitted.

Heating Stage 2 - To enter Heating Stage 2 mode, W becomes active (Y already active). The compressor relay remains on. EH1 is turned on immediately. With continuing Heating Stage 2 demand, EH2 will turn on after 10 minutes. The EH2 will not turn on in heating (or will turn off if already on) if loop temperature is above approximately 50°F (FP1 >45°F).

Emergency Heat - In Emergency Heat mode, W becomes active while Y is not active. EH1 is turned on immediately. With continuing Emergency Heat demand, EH2 will turn on after 5 minutes. The FP1 and FP2 temperatures do not effect emergency heat operation.

Table 1 - Status LED Description

Description of Operation	LED	Alarm Relay
Normal Mode	On	Open
Normal Mode with UPS Warning	On	Cycle (closed 5 sec., Open 25 sec.)
CXM is non-functional	Off	Open
Fault Retry	Slow Flash	Open
Lockout	Fast Flash	Closed
Over/Under Voltage Shutdown	Slow Flash	Open (Closed after 15 minutes)
Test Mode - No fault in memory	Flashing Code 1	Cycling Code 1
Test Mode - HP Fault in memory	Flashing Code 2	Cycling Code 2
Test Mode - LP Fault in memory	Flashing Code 3	Cycling Code 3
Test Mode - FP1 Fault in memory	Flashing Code 4	Cycling Code 4
Test Mode - FP2 Fault in memory	Flashing Code 5	Cycling Code 5
Test Mode - CO Fault in memory	Flashing Code 6	Cycling Code 6
Test Mode - Over/Under shutdown in memory	Flashing Code 7	Cycling Code 7
Test Mode - UPS in memory	Flashing Code 8	Cycling Code 8

Ultra Classic Electrical Wiring Diagram - 96B0037N02

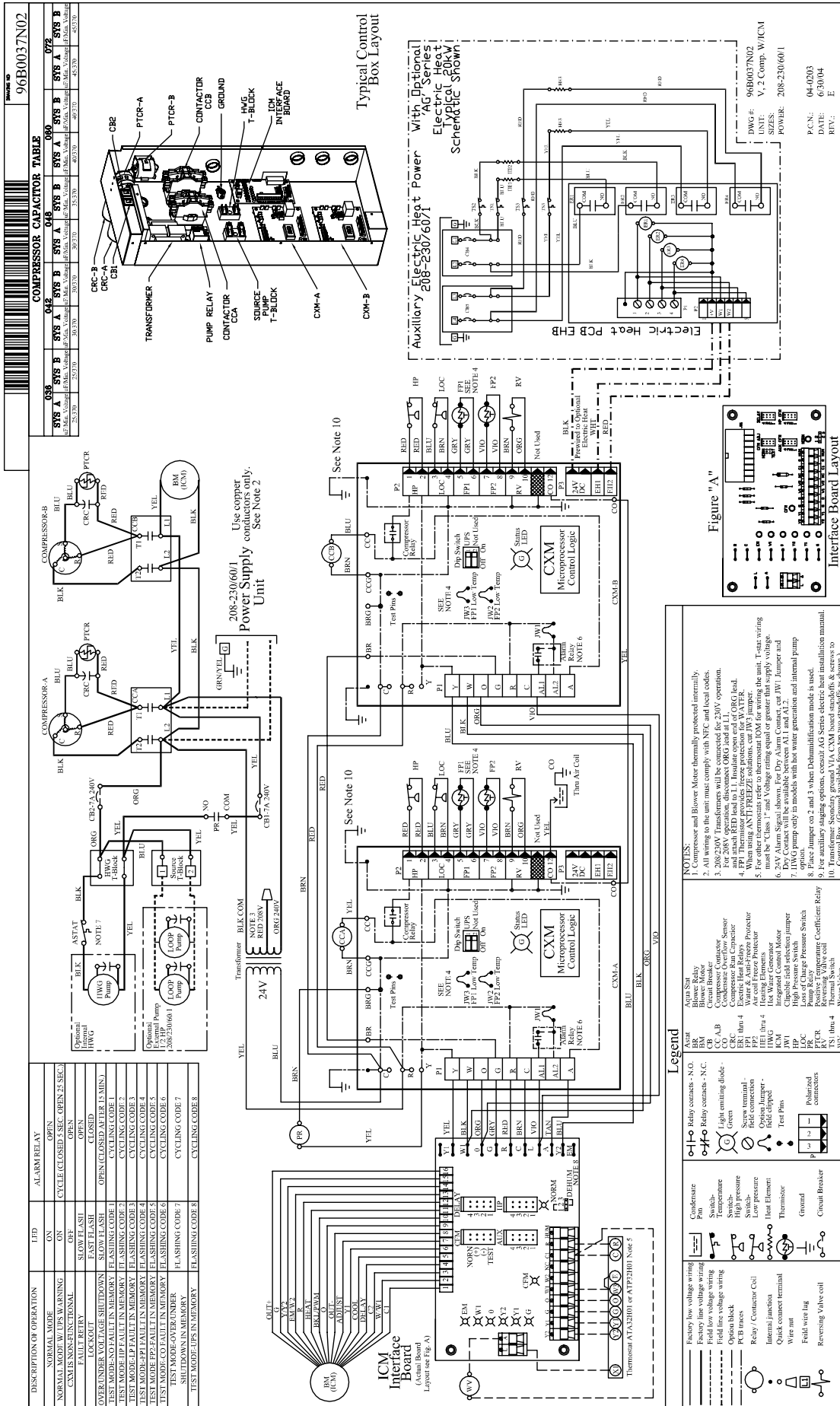

Auxiliary Heat Typical Application

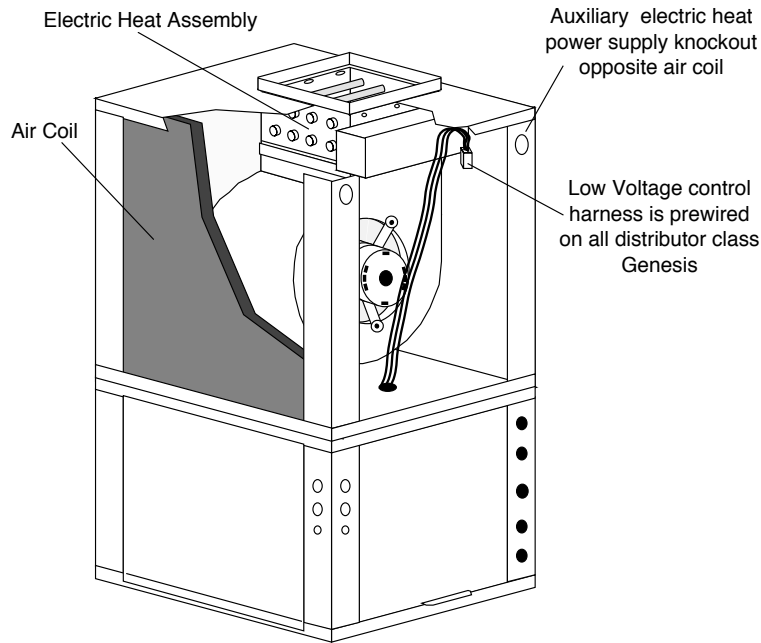

Auxiliary Heat Ratings

AG Series Auxiliary Electric Heat Model	Models					kW Rating (kW)		Btuh Rating (Btuh)		Minimum CFM Required
	036	042	048	060	072	240V	208V	240V	208V	
AGM5A	●					4.8	3.6	16300	12300	500
AGM8A	●					7.6	5.7	25900	19400	650
AGM10A	●					9.6	7.2	32700	24600	650
AGM12A	●					11.4	8.6	38900	29200	750
AGL10A		●	●	●	●	9.6	7.2	32700	24600	1300
AGL15A		●	●	●	●	14.4	10.8	49100	36900	1350
AGL20A		●	●	●	●	19.2	14.4	65500	49200	1350

● denotes compatibility

Rev.: 06/04/04D

Note: Vertical units rated for zero clearance for both unit and duct

Auxiliary Heat Electrical Data

Electric Heat Model	Supply Circuit	Heater Amps		Min Circ Ampacity		Max Fuse		Supply Wire	
		240V	208V	240V	208V	240V	208V	Min AWG	Max Ft
AGM5A	Single	20.0	17.3	25.0	21.6	25	25	10	70
AGM8A	Single	31.7	27.5	39.6	34.4	40	35	8	70
AGM10A	Single	40.0	34.7	50.0	43.4	50	45	6	90
AGM12A	Single	47.5	41.2	59.4	51.5	60	60	6*	70
	Dual - L1/L2	31.7	27.5	39.6	34.4	40	35	8	70
	Dual - L3/L4	15.8	13.7	19.8	17.1	20	20	12	50
AGL10A	Single	40.0	34.7	50.0	43.4	50	45	6	80
AGL15A	Single	60.0	52.0	75.0	65.0	80	70	6*	50
	Dual - L1/L2	40.0	34.7	50.0	43.4	50	45	6	80
	Dual - L3/L4	20.0	17.3	25.0	21.6	25	25	10	70
AGL20A	Single	80.0	69.3	100.0	86.6	100	90	2	100
	Dual - L1/L2	40.0	34.7	50.0	43.4	50	45	6	80
	Dual - L3/L4	40.0	34.7	50.0	43.4	50	45	6	80

All heaters rated single phase 208-240V 60 Hz.

Wire length based on one way measurement with 2% voltage drop.

Rev.: 2/28/01M

Wire size based on 60°C (*90°C) copper conductor.

All fuses UL Class K General Purpose.

All models 12kW or larger feature internal fusing.

Engineering Guide Specifications

General

The water source heating/cooling units shall be vertical upflow air discharge. Units shall be ARI/ISO/ASHRAE 13256-1 (ground-source closed-loop) performance certified and listed by a nationally recognized safety-testing laboratory or agency, such as Underwriter's Laboratory (UL) or Canadian Standards Association (CSA-US). Each unit shall be water run-tested at the factory. Each unit shall be pallet mounted and shipped in clear shrink wrap for visual shipping damage inspection. The units shall be warranted by the manufacturer against defects in materials and workmanship for a period of five years on all parts, and ten years on the compressor and refrigerant circuit parts with a service labor allowance during the first 30 days. An optional extended warranty is available for the Ultra Classic™ Series units, which adds a labor allowance and trip charge. The water source units shall be designed to operate with entering fluid temperature between 25°F and 110°F.

Casing & Cabinet

The cabinet shall be fabricated from heavy-gauge galvanized steel. The interior shall be insulated with 1/2" thick, multi-density, coated glass fiber with edges sealed or tucked under flanges to prevent the introduction of glass fibers into the discharge air. Three blower compartment and four compressor compartment access panels shall be provided and shall be removable with supply and return ductwork in place. The internal component layout shall provide for major service with the unit in-place for restricted access installations.

A duct collar shall be provided on the supply air opening. Standard-size 1" filters shall be provided with each unit. Units shall have filter brackets. The units shall have an insulated divider panel between the air handling section and the compressor section to minimize the transmission of compressor noise, and to permit operational service testing without air bypass. Units shall be supplied with left or right horizontal air inlet.

Refrigerant Circuit

All units shall contain two independent sealed refrigerant circuits each employing a hermetic motor-compressor, bidirectional thermal expansion valve, finned tube E-Coated air-to-refrigerant heat exchanger, reversing valve, coaxial tube water-to-refrigerant heat exchanger and service ports. An optional desuperheater coil shall be provided on the first stage.

Compressors shall be high-efficiency rotary or advanced scroll type designed for heat pump duty and mounted on vibration isolators. Compressor motors shall be single phase PSC with internal overload protection. A factory installed bidirectional filter drier shall be provided on rotary compressor models. The finned tube coil shall be sized for low-face velocity and constructed of lanced aluminum fins bonded to rifled copper tubes in a staggered pattern not less than four rows deep. The entire coil shall be E-Coated for added protection against corrosion.

The coaxial water-to-refrigerant heat exchangers shall be designed for close approach temperatures and be constructed of a convoluted copper (optional cupronickel) inner tube and a steel outer tube. The thermal expansion valves shall provide proper superheat over the entire fluid

temperature range with minimal "hunting". The valves shall operate bi-directionally without the use of check valves.

The water-to-refrigerant heat exchangers, optional desuperheater coil and refrigerant suction lines shall be insulated to prevent condensation at low liquid temperatures.

Fan Motor and Blower

The fan shall be a direct drive centrifugal type with a dynamically balanced wheel. The housing and wheel shall be designed for quiet low outlet velocity operation and of galvanized steel construction. Tight fan housing geometry shall not be permitted. The fan housing shall be removable from the unit without disconnecting the supply air ductwork for servicing of the fan motor. The fan motor shall be an ICM2 variable speed type. The ICM2 fan motor shall provide soft starting, maintain constant CFM over its static operating range and provide airflow adjustment on its control board. The fan motor shall be isolated from the housing by rubber grommets. The motor shall be permanently lubricated and have thermal overload protection.

Electrical

CXM Control - A microprocessor-based compressor controller (CXM) shall be provided to monitor and control unit operation. The control shall provide compressor and electric heater sequencing, high and low pressure monitoring, field selectable water and air coil freeze protection sensing, condensate overflow sensing, over/under voltage monitoring, and unit performance sentinel (UPS). The control shall also provide for water valve connection, a test mode, short cycle protection, random start-up, as well as fault LED, fault memory, and intelligent fault retry.

The control shall employ quick attach harness assemblies for low voltage connections to the control board to aid in troubleshooting or replacement. An integral terminal block with screw terminals shall be provided on the control for all field low voltage connections. A circuit breaker protected 75VA transformer shall be employed. Line voltage lugs shall be provided for unit wiring. Units shall have knockouts for entrance of low and line voltage wiring. The fan motor and control box shall be harness plug-connected for easy removal.

Piping

Supply and return water connections for each circuit (4 total) shall be 1" FPT brass swivel fittings which provide a union and eliminate the need for pipe wrenches and sealants when making field connections. Individual connections to each of the coaxial heat exchangers shall allow different source fluids for each refrigerant circuit. Desuperheater connections shall be 1/2" FPT copper threaded fittings mechanically fastened to unit cabinet, eliminating the need for backup wrenches when making filed piping connections. All water piping shall be insulated to prevent condensation at low liquid temperatures. The condensate connection shall be a 3/4" FPT with internal-trap.

Accessories & Options

Hot Water Generator

An optional heat reclaiming desuperheater coil of vented double-wall copper construction suitable for potable water shall be provided on the first stage circuit. The coil and hot water circulating pump shall be factory mounted inside the unit. A high limit shut off switch shall be provided.

Cupro-Nickel Heat Exchanger

An optional corrosion resistant CuNi coaxial heat exchanger shall be factory installed in lieu of the standard copper construction.

Thermostat (field installed)

A multistage auto-changeover electronic digital thermostat shall be provided. The thermostat shall offer 3 heating and 2 cooling stages with precise temperature control. An OFF-HEAT-AUTO-COOL-EMERG system switch, OFF-AUTO fan switch, and indicating LED's shall be provided. The thermostat shall read out in °F or °C. An optional remote indoor sensor and outdoor sensor use shall be available. The thermostat shall provide an outdoor temperature display.

Flow Controller (field installed)

A self-contained module shall provide all fluid pumping, fill and connection requirements for ground-source closed-loop systems up to 20 GPM. The Flow Controller shall provide 1" pump isolation valves and 3-way service valves. Pump heads shall be removable from the volute for easy replacement. The Flow Controller shall be enclosed in a galvanized case and fully insulated with urethane foam to prevent condensation. The Flow Controller shall have a 5-year warranty on all parts.

Auxiliary Heater (field installed)

An internally mounted electric heater shall provide supplemental and/or emergency heating capability when used with the 3 stage heating thermostats.

1" Filter Rack/Duct Collar (field installed)

A filter rack/duct collar shall be provided for each vertical unit, to accept standard-size 1" filters.

Water Manifold Assembly

A water manifold assembly shall be provided for use when a single water source is desired. The manifold shall terminate with two 1" FPT swivel fittings for field connection.

Warranty Information

ClimateMaster Ultra Classic™ Series residential warranty reflects the reliability built in to every unit and includes five years on all parts, and ten years on the compressor and refrigerant circuit parts with a service labor allowance during the first 30 days. An optional extended warranty is available for the Ultra Classic™ Series units, which adds a labor allowance and trip charge. See extended warranty certificate (RP405) for details.

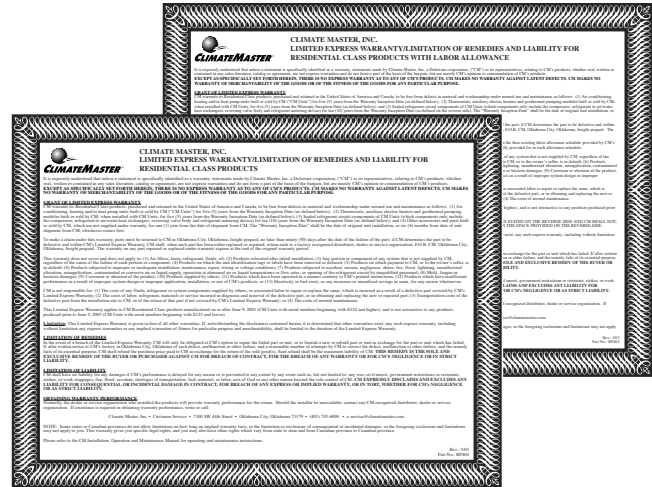



7300 S.W. 44th Street
Oklahoma City, OK 73179
Phone: (405) 745-6000
Fax: (405) 745-6058
www.climatemaster.com



Locally Available Through:

ClimateMaster works continually to improve its products. As a result, the design and specifications of each product at the time of order may be changed without notice and may not be as described herein. Please contact ClimateMaster's Customer Service Department at 1-405-745-6000 for specific information on the current design and specifications. Statements and other information contained herein are not express warranties and do not form the basis of any bargain between the parties, but are merely ClimateMaster's opinion or commendation of its products.

As an ENERGY STAR® Partner ClimateMaster has determined that this product meets the ENERGY STAR® guidelines for energy efficiency.