

**LEGEND**

- Factory Low voltage Wiring
- Factory Line Voltage Wiring
- Field Low voltage Wiring
- Field Line voltage Wiring
- Printed Circuit Trace
- Optional Block
- Optional Block
- Capacitor
- Circuit Breaker
- Condensate Pan
- Ground
- High Pressure Switch
- LED
- Low Pressure Switch
- Mate-N-Lock
- Multi Splice Connector
- Optional
- OVERLOAD
- Relay contacts - N.C.
- Relay contacts - N.O.
- Relay / Contactor Coil
- Solenoid Coil
- Splice Cap
- Temperature Switch
- Thermistor
- Wire Nut

- AL Alarm Relay Contacts
- BM Blower Motor
- BMC Blower Motor Capacitor
- BR Blower Relay
- CAP Capacitor
- CB Circuit Breaker
- CC Compressor Contactor
- CO Condensate Over/low Sensor
- CR Compressor Relay
- CTB Common Terminal Block
- CS Current Sensor
- DHW Domestic Hot Water
- DM Damper Motor
- DTS Discharge Temperature Switch
- ES End Switch
- EWTS Entering Water Temp Sensor
- FP1 Sensor, low temp protection, water coil
- FP2 Sensor, low temp protection, air coil
- FSS Fan Speed Switch
- HP High Pressure Switch
- HPWS High Pressure Water Switch
- HR Heating Relay
- JW Jumper Wire
- LAT Leaving Air Temperature
- LOC Loss of Charge Pressure Switch
- LOR Lock Out Relay
- LWTS Leaving Water Temp Sensor
- MOD Modulating Water Valve
- MS Manual Starter
- MSC Multi Splice Connector
- MWV Motorized Water Valve
- PB Power Terminal Block
- PDB Power Distribution Block
- POT Potentiometer
- P1 Field Wiring Terminal Block
- RAS Return Air Sensor
- RVS Reversing Valve Solenoid
- SAC Start Assist Capacitor
- TB Terminal Block
- TRANS Transformer
- TS Terminal Strip
- UMT Unit Mounted Thermostat

- NOTES:**
1. Compressor and Blower Motor thermally protected internally.
  2. All wiring to the unit must comply with NEC and local codes.
  3. Transformer is wired 460V (BLK/RED) lead for 460/60/3 units, 575 (GRY) leads for 575/60/3 or 380V (VIO) lead for 380/50/3, for 415/50/3 switch VIO & BRN leads at L1 & insulate VIO lead.
  4. FP1 provides low temperature protection for WATER. When using ANTI-FREEZE solutions, cut JW3 jumper.
  5. Typical heat pump thermostat wiring shown. Refer to thermostat IOM for wiring to the unit. T-Stat wiring must be "Class 1" and voltage rating equal to or greater than unit supply voltage.

6. 24V Alarm signal shown. For Dry Alarm contact between AL1 & AL2, cut JW1 for CXM/DXMM Gen2 or JW4 DXM.
7. Transformer Secondary Ground via CXM/DXMM board standoffs and screws to Control Box.
- BM1. Fan motors factory wired for Medium speed. For High or Low speed remove BLU wire from fan motor speed tap 'M' and connect to 'H' for High or 'L' for Low.
- BM2. For Low Speed remove BLK wire from BR6 & replace with RED.
- BM3. For blower motors with leads. For Medium or Low speed disconnect BLK wire from BR6. Connect BLK and ORG/VIO wire together. Connect RED for Low or BLU for MED to BR6.
- BM4. Blower motor factory wired to Medium speed. For Low speed remove BLU wire from Medium tap and connect to Low Speed Tap. For High speed remove BLU wire from existing Speed Tap and remove BRN jumper wire from High Speed Tap. Connect BLU wire to High Speed Tap. Tape off unconnected end of BRN jumper.

- MPC1. Factory cut JW1 (CXM) or JW4 (DXM) jumper. Dry Contact will be available between AL1 and AL2.
- MPC2. Refer to MPC Installation application, and Operation Manual For Control Wiring to the unit.
- MPC3. ASW sensors are not required on Water-Water application. ASW06-ASW08 (Water-Air Only) move jumper to LSTAT. ASW13-ASW15 move jumper to Rnet.

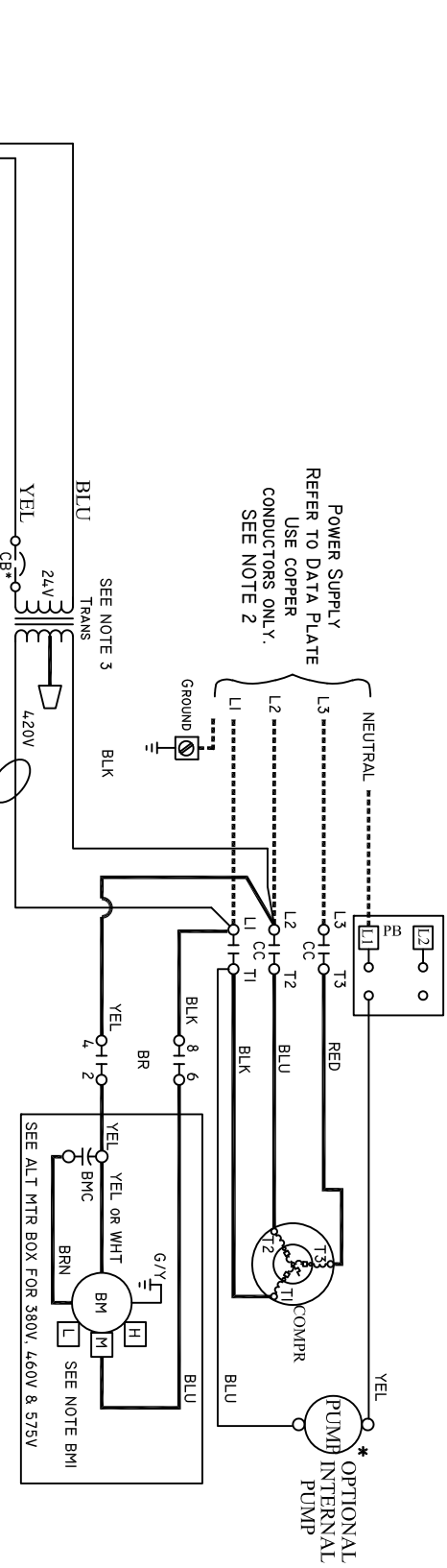
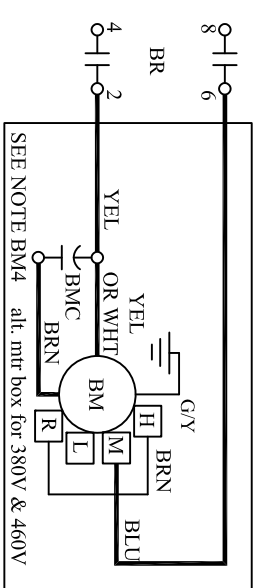

**TRANSFORMER PRIMARY LEAD COLORS**

PRIMARY VOLTAGE	PRIMARY LEAD COLOR	VIO
380V	BRN	
420V	BLK/RED	
460V	BLK/RED	
575V	GRY	

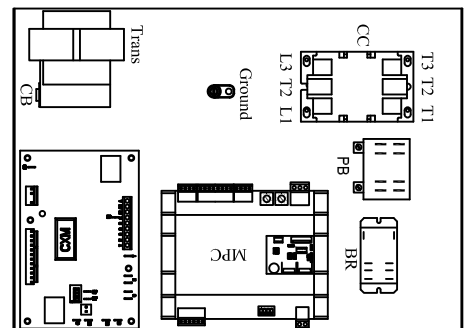
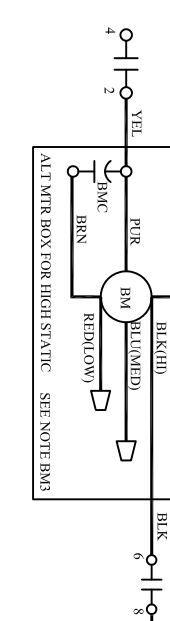
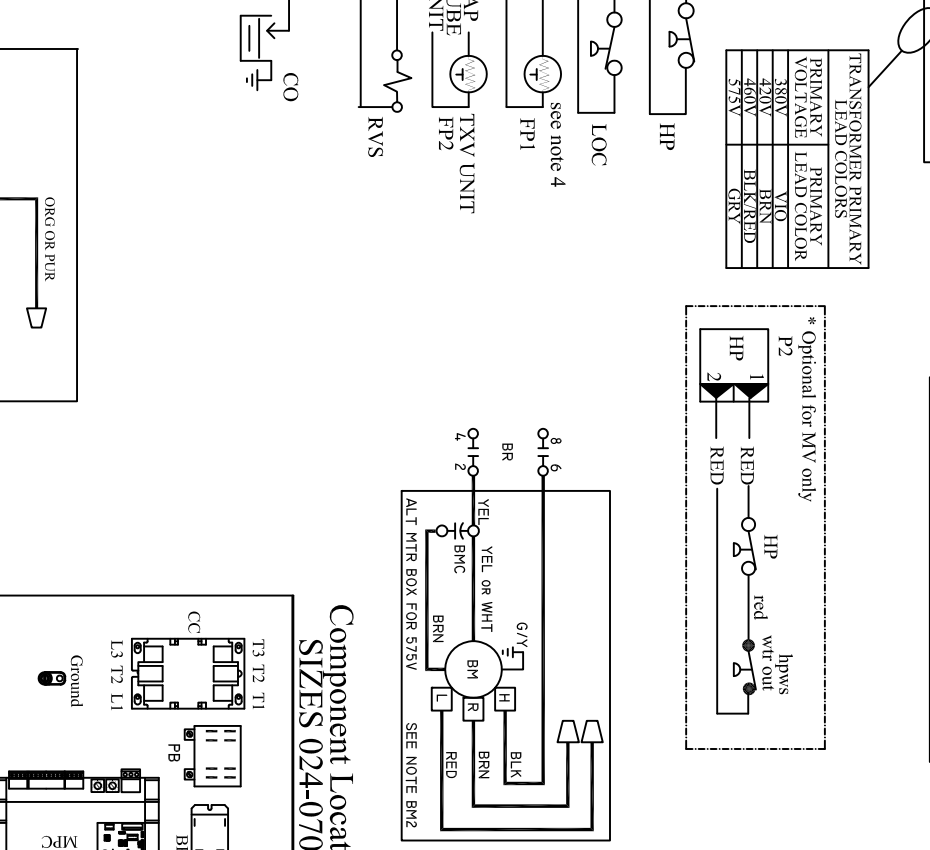
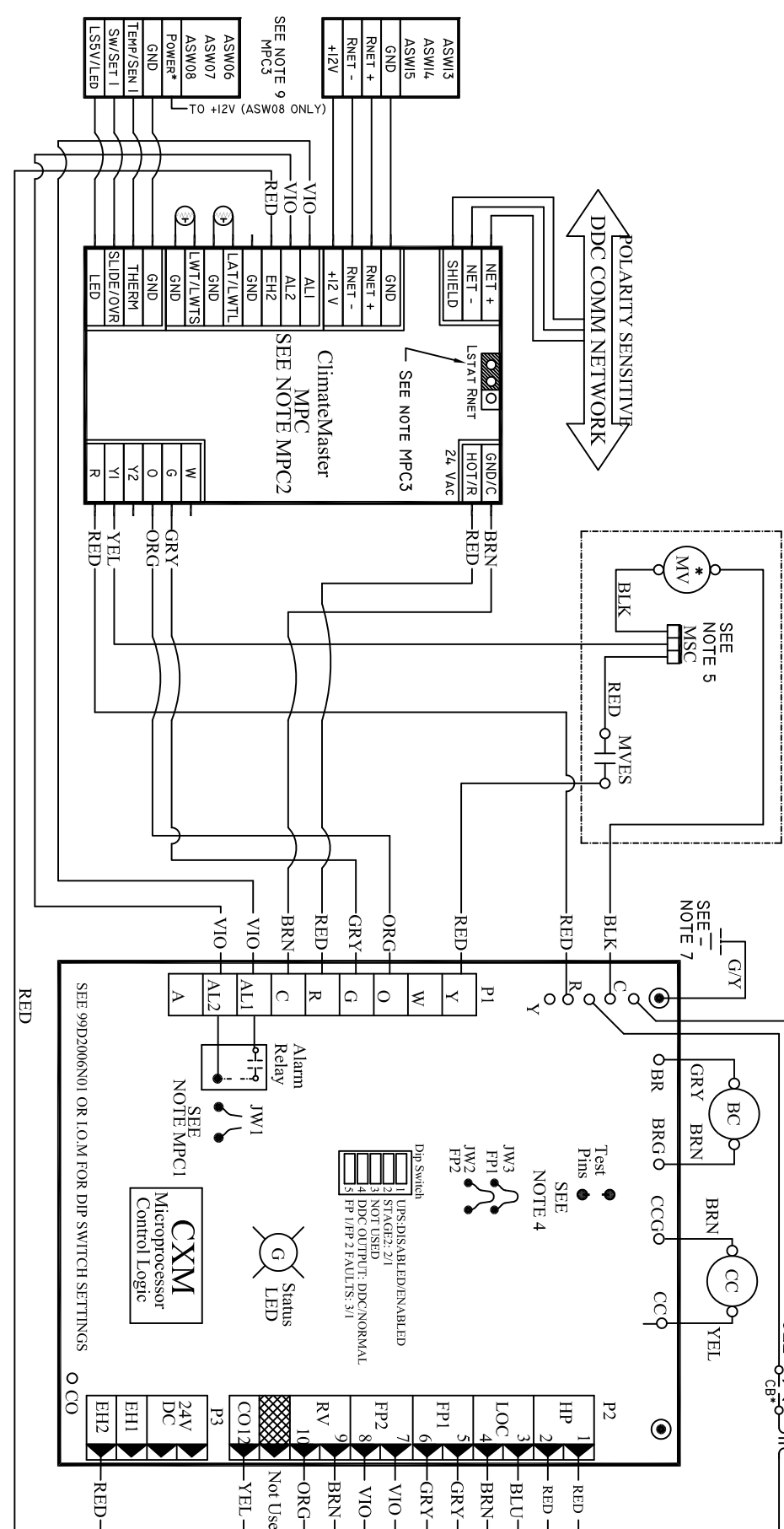
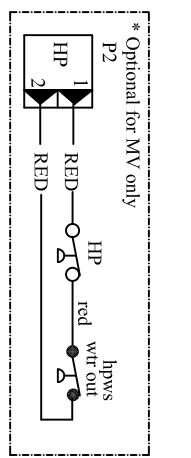

**Component Location**  
SIZES 024-070