

BLOWER SPEEDS	1	2	3	4	5
BLW(L) TO BR2(6)	BR2(3)	BR2(3)	BR2(7)	BR2(6)	BR2(4)
HI + MED	BR2(6)	BR2(6)	BR2(3)	BR2(7)	BR2(4)
HI + LOW	BR2(6)	BR2(6)	BR2(3)	BR2(7)	BR2(4)
MED + LOW	BR2(6)	BR2(6)	BR2(3)	BR2(7)	BR2(4)

- NOTES:
- Compressor and Blower Motor thermally protected internally.
 - All wiring to the unit must comply with NEC and local codes.
 - 208/230V Transformer will be connected for 208V operation. For 230V operation, disconnect RED lead at L2 and attach ORG lead to L2. Insulate open end of RED lead. 380/420V Transformer will be connected for 380V operation. For 420V operation, disconnect VIO lead at L2 and attach BRN lead to L2. Insulate open end of VIO lead. 460V Transformer will be connected to (BLK/RED) lead. Transformer will be connected to (GRY) lead.
 - FPI provides low temperature protection for WATER. When using ANTI-FREEZE solutions, cut JW3 jumper.
 - Typical heat pump thermostat wiring shown. Refer to thermostat IOM for wiring to the unit. T-Stat wiring must be "Class 1" and voltage rating equal to or greater than unit supply voltage.

- 24V Alarm signal shown. For Dry Alarm contact between AL1 & AL2, cut JW1 for CXM/DXM Gen2 or JW4 DXM.
- Transformer Secondary Ground via CXM/DXM board standoffs and screws to Control Box.
- Blower motor is factory wired for high & low speeds. No other combination is available.
- Blower motor is factory wired for medium & high speeds. For any other combination of speeds, at the motor attach the black wire to the higher of the two desired speed taps, and the blue wire to the lower of the two desired speed taps.
- Factory cut JW1 (CXM) or JW4 (DXM) jumper. Dry Contact will be available between AL1 and AL2.
- Refer to MPC Installation application, and Operation Manual For Control Wiring to the unit.
- MPC3, ASW sensors are not required on Water-Water application. ASW06-ASW08 (Water-Air Only) move jumper to LSTAT, ASW13-ASW15 move jumper to Rnet.

LEGEND

- Factory Low voltage Wiring
- Factory Line Voltage Wiring
- Field Low voltage Wiring
- Field Line voltage Wiring
- Printed Circuit Trace
- Optional Wiring
- Optional Block
- Capacitor
- Circuit Breaker
- Condensate Pan
- Ground
- High Pressure Switch
- LED
- Low Pressure Switch
- Mate-N-Lock
- Multi Splice Connector
- Optional
- OVERLOAD
- Relay contacts - N.C.
- Relay contacts - N.O.
- Relay / Contactor Coil
- Solenoid Coil
- Splice Cap
- Temperature Switch
- Thermistor
- Wire Nut

- AL Alarm Relay Contacts
- BM Blower Motor
- BMC Blower Motor Capacitor
- BR Blower Relay
- CBP Capacitor
- CB Circuit Breaker
- CC Compressor Contactor
- CO Condensate Over/low Sensor
- CR Compressor Relay
- CTB Common Terminal Block
- CS Current Sensor
- DHW Domestic Hot Water
- DM Damper Motor
- DTS Discharge Temperature Switch
- ES End Switch
- EVT Sensor, low temp protection, water coil
- FPI Sensor, low temp protection, air coil
- FP2 Sensor, low temp protection, air coil
- FSS Fan Speed Switch
- HP High Pressure Switch
- HPWS High Pressure Water Switch
- HR Heating Relay
- JW Jumper Wire
- LAT Leaving Air Temperature
- LOC Loss of Charge Pressure Switch
- LOR Lock Out Relay
- LWTS Leaving Water Temp Sensor
- MOD Modulating Water Valve
- MS Manual Starter
- MSC Multi Splice Connector
- MWV Motorized Water Valve
- PB Power Terminal Block
- PDB Power Distribution Block
- POT Potentiometer
- P1 Field Wiring Terminal Block
- PR Pump Relay
- RAS Return Air Sensor
- RVS Reversing Valve Solenoid
- SAS Supply Air Sensor
- SAC Start Assist Capacitor
- TB Terminal Block
- TRANS Transformer
- TS Terminal Strip
- UMT Unit Mounted Thermostat

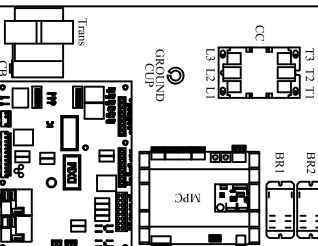
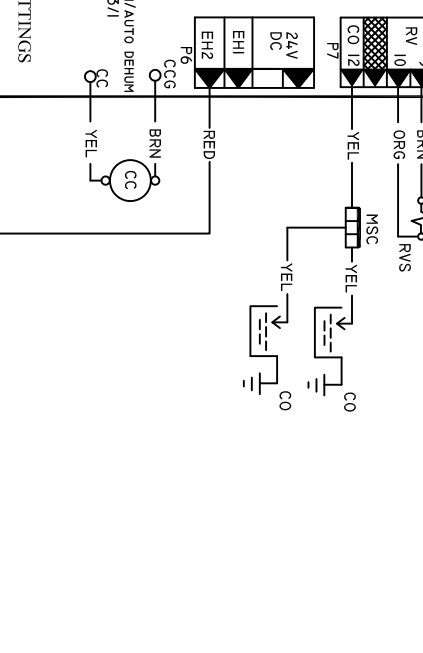
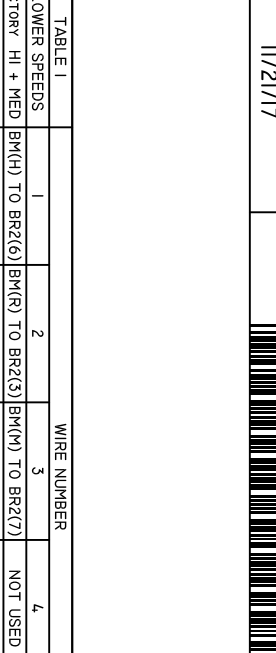
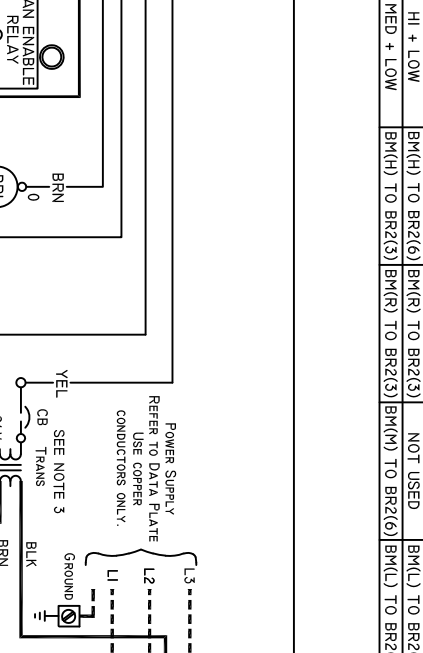
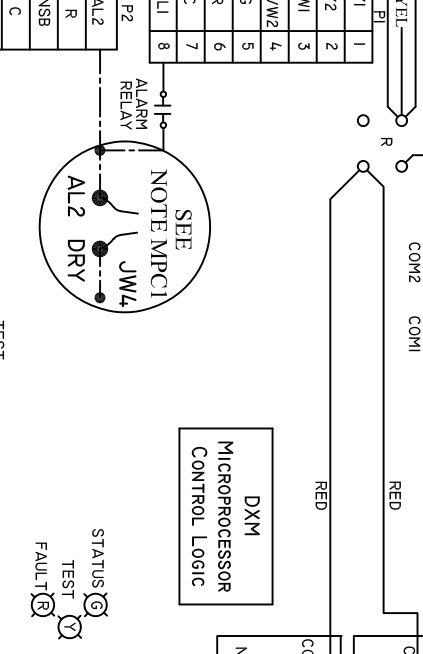
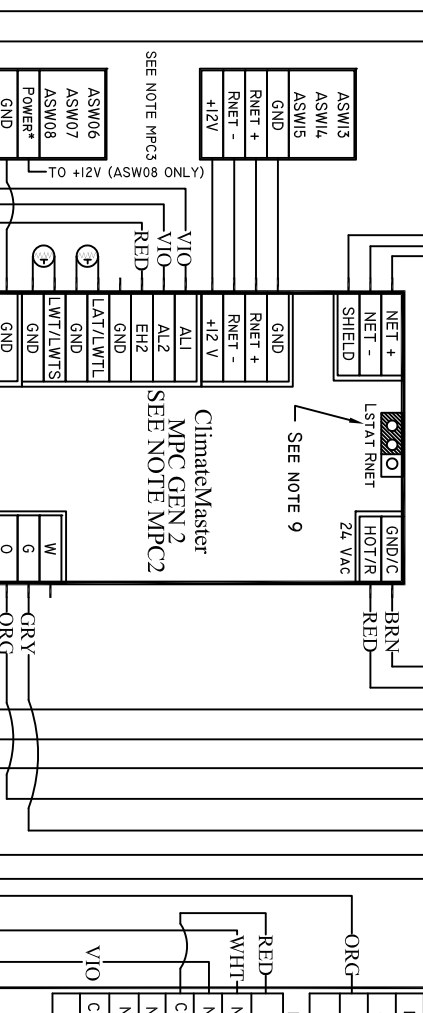
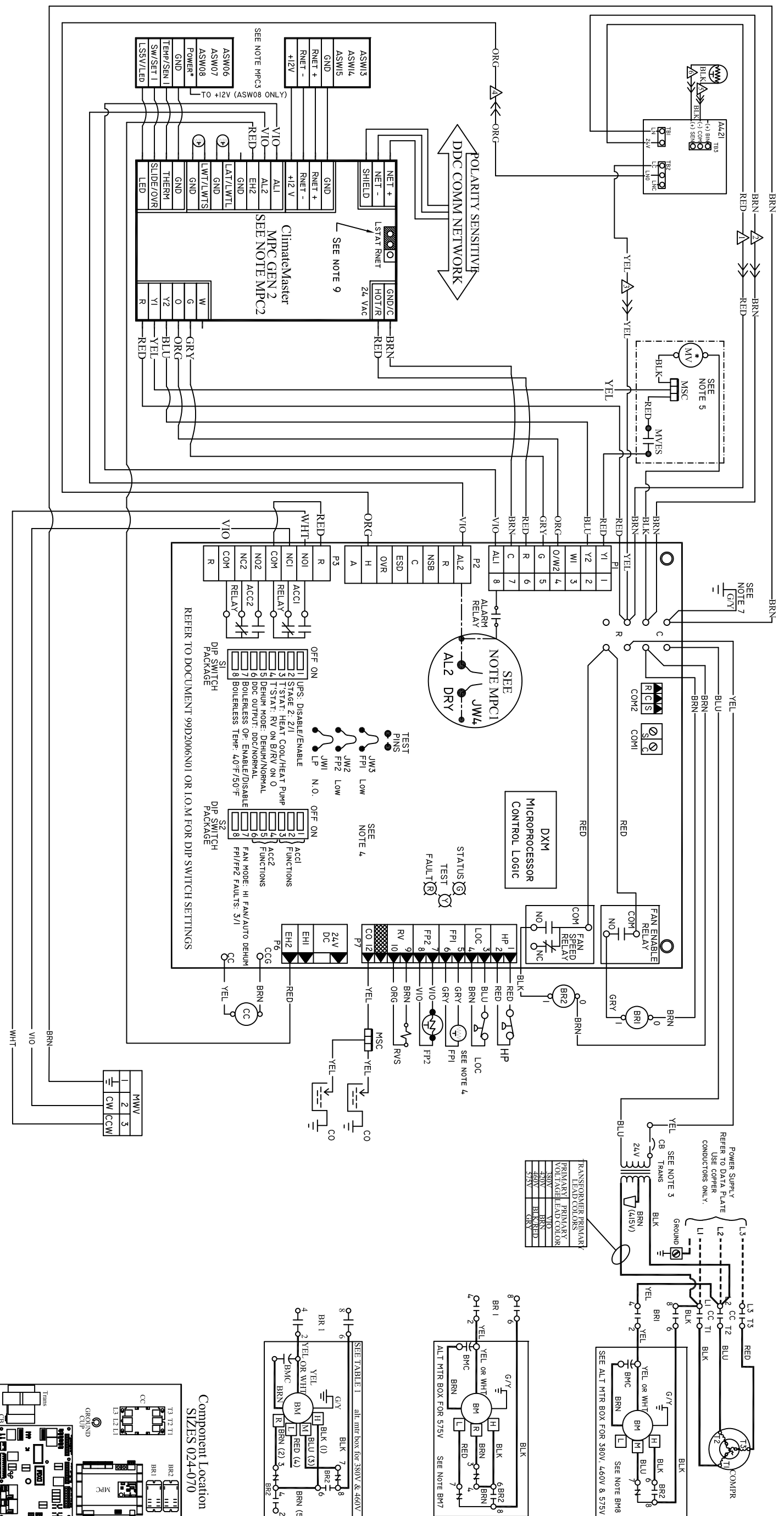

Component Location
SIZES 024-070

SEE TABLE 1 all unit box for 380V & 460V

all unit box for 380V & 460V